



ENGLISH

FRANÇAIS

ESPAÑOL

# OWNER'S MANUAL FRENCH DOOR REFRIGERATOR

Please read this owner's manual thoroughly before operating and keep it handy for reference at all times.

LMXS30796\*

LMXC23796\*



MFL69497002

[www.lg.com](http://www.lg.com)

ENGLISH

# TABLE OF CONTENTS

## 3 PRODUCT FEATURES

---

## 4 IMPORTANT SAFETY INSTRUCTIONS

---

## 7 COMPONENTS

---

- 7 Refrigerator Exterior
- 8 Refrigerator Interior

## 9 INSTALLATION

---

- 9 Installation Overview
- 10 Specifications
- 11 Unpacking the Refrigerator
- 11 Choosing the Proper Location
  - 11 - Flooring
  - 12 - Ambient Temperature
  - 12 - Measuring Clearances
- 12 Removing/Assembling the Refrigerator Door Handles
- 13 Removing/Assembling the Freezer Drawer Handle
- 13 Removing/Assembling the Doors and Drawers
  - 14 - Removing the Left Refrigerator Door
  - 15 - Removing the Right Refrigerator Door
  - 16 - Assembling the Right Refrigerator Door
  - 17 - Assembling the Left Refrigerator Door
  - 18 - Removing the CustomChill™ Drawer
  - 19 - Assembling the CustomChill™ Drawer
  - 19 - Removing the Freezer Drawer
  - 21 - Assembling the Freezer Drawer
- 22 Connecting the Water Line
  - 22 - Before You Begin
  - 22 - Water Pressure
  - 22 - What You Will Need
  - 23 - Water Line Installation Instructions
- 25 Turning On the Power
- 26 Leveling and Door Alignment
  - 26 - Leveling
  - 26 - Door Alignment

## 27 HOW TO USE

---

- 27 Before Use
- 28 Control Panel
  - 28 - Control Panel Features
- 31 Smart Features
- 35 In-Door Ice Bin
  - 35 - Detaching the In-Door Ice Bin
  - 35 - Assembling the In-Door Ice Bin
- 36 Automatic Ice maker
  - 36 - Turning the Automatic Ice maker On or Off
  - 37 - When You Should Turn the Ice maker Off
  - 37 - Normal Sounds You May Hear
  - 37 - Preparing for Vacation
- 38 Ice and Water Dispenser
  - 38 - Dispenser
  - 38 - Using the Dispenser
  - 38 - Locking the Dispenser
  - 38 - Cleaning the Dispenser Stand
- 39 Storing Food
  - 39 - Food Preservation Location
  - 40 - Food Storage Tips
  - 40 - Storing Frozen Food
- 42 Glide'N'Access™
- 42 EasyReach™
- 42 Humidity Controlled Crisper
- 43 Detaching and Assembling the Storage Bins
- 44 InstaView Door-in-Door
- 46 CustomChill™ Drawer
- 47 Adjusting the Refrigerator Shelves

## 48 MAINTENANCE

---

- 48 Cleaning
- 49 Replacing the Fresh Air Filter
- 49 Replacing the Water Filter

## 52 SMART DIAGNOSIS™

---

- 52 Using Smart Diagnosis™

## 53 TROUBLESHOOTING

---

## 63 WARRANTY

---

## PRODUCT FEATURES

\* Depending on the model, some of the following functions may not be available.

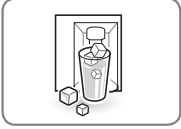

### FILTERED WATER AND ICE DISPENSER

The water dispenser dispenses fresh, chilled water.  
The ice dispenser dispenses cubed and crushed ice.



### DOOR ALARM

The Door Alarm function is designed to prevent refrigerator malfunctioning that could occur if a refrigerator door or freezer drawer remains open. If a refrigerator door or freezer drawer is left open for more than 60 seconds, a warning alarm sounds at 30 second intervals.

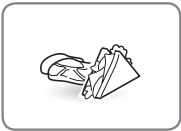

### CUSTOMCHILL™ DRAWER

The CustomChill™ Drawer provides storage space with a variable temperature control that keeps the compartment either colder or warmer than the refrigerator. Use it to store meat and seafood, cold drinks, deli snacks, or chilled wine.

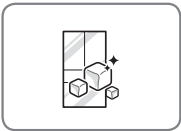

### ICE PLUS

Ice production can be increased by approximately 20 percent when the freezer section is maintained at the coldest temperature for a 24-hour period.



### HUMIDITY CONTROLLED CRISPER

The Humidity Controlled Crisper is designed to help keep your fruits and vegetables fresh and crisp.

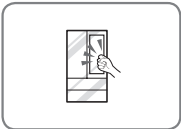

### INSTAVIEW DOOR-IN-DOOR

Use this space to store frequently used items like beverages and snacks. Knock twice on the glass to see at a glance if you need to stock up, without opening the refrigerator door.

# IMPORTANT SAFETY INSTRUCTIONS

## READ ALL INSTRUCTIONS BEFORE USING THE APPLIANCE.

This guide contains many important safety messages. Always **read and obey** all safety messages.



This is the safety alert symbol. It alerts you to safety messages that inform you of hazards that can kill or hurt you or others, or cause damage to the product.

All safety messages will be preceded by the safety alert symbol and the hazard signal word **WARNING** or **CAUTION**. These words mean:



**WARNING** You can be killed or seriously injured if you do not follow instructions.



**CAUTION** Indicates an imminently hazardous situation which, if not avoided, may result in minor or moderate injury, or product damage.



**WARNING**

**To reduce the risk of fire, electric shock, or personal injury when using your product, basic safety precautions should be followed, including the following:**

### Power

- NEVER unplug your refrigerator by pulling on the power cord. Always grip the plug firmly and pull it straight out from the outlet.
- If the supply cord is damaged, it must be replaced by the manufacturer or its service agent or a similarly qualified person in order to avoid a hazard. Do not use a cord that shows cracks or abrasion damage along its length or at either the plug or connector end.
- Do not use an uncertified power outlet.
- Unplug the power plug immediately in the event of a blackout or thunderstorm.
- Plug in the power plug with the power cord facing downward.

### Installation

- Contact an authorized service center before you install or relocate the refrigerator.
- When moving your refrigerator away from the wall, be careful not to roll over or damage the power cord.
- Prior to use, ensure that you are connecting this product to a dedicated, grounded electrical outlet rated for use with this product (115V, 60Hz, AC only). It is the user's responsibility to replace a standard 2-prong wall outlet with a standard 3-prong wall outlet.
- Do not install the refrigerator where there may be a danger of the unit falling.

### Use

- DO NOT allow children to climb, stand, or hang on the refrigerator doors or on the shelves in the refrigerator. They could damage the refrigerator and seriously injure themselves.
- Do not hang on to or place heavy objects on the refrigerator's dispenser.
- Do not place heavy or dangerous objects (bottles with liquid) on the refrigerator.
- Do not put live animals inside the refrigerator.
- Do not allow children to climb into the product when it is in use.
- In the event of a gas leak (propane/LPG), ensure adequate ventilation and contact an authorized service center before resuming use. Do not touch or disassemble the electric outlet of the refrigerator.
- In the event of a refrigerant leak, move flammable objects away from the refrigerator. Ensure adequate ventilation and contact an authorized service center.
- Do not use or place flammable substances (chemicals, medicine, cosmetics, etc) near the refrigerator or store them inside the refrigerator. Do not place the refrigerator in the vicinity of flammable gas.

## **READ ALL INSTRUCTIONS BEFORE USING THE APPLIANCE.**

To reduce the risk of fire, electric shock, or personal injury when using your product, basic safety precautions should be followed, including the following:

- This product is not to be used for special purposes such as the storage of medicine or test materials or for use on ships, etc.
- Unplug the power plug before cleaning or repairing the refrigerator.
- When you replace the light bulb in the refrigerator, unplug the refrigerator or turn off the power.
- Do not modify or extend the power cord.
- Do not use a dryer to dry the interior. Do not light a candle to remove interior odors.
- For your safety, this appliance must be properly grounded. Have the wall outlet and the circuit checked by a qualified electrician to make sure the outlet is properly grounded.
- Do not use an outlet that can be turned off with a switch. Do not use an extension cord. It is the user's responsibility to replace a standard 2-prong wall outlet with a standard 3-prong wall outlet.
- Do not, under any circumstances, cut or remove the third (ground) prong from the power cord.
- Do not use an adapter plug and plug the power plug into a multi-outlet extension cord.
- Disconnect the power cord immediately if you hear a noise, smell a strange odor or detect smoke coming from the appliance.
- Turn the power off if water or dust penetrates into the refrigerator. Call a service agent.
- Do not disassemble or modify the refrigerator.
- Do not put hands, feet, or metal objects below or behind the refrigerator.
- Do not operate the refrigerator or touch the power cord with wet hands.
- In refrigerators with automatic icemakers, avoid contact with the moving parts of the ejector mechanism or with the heating element that releases the cubes. Do not place fingers or hands on the automatic ice-making mechanism while the refrigerator is plugged in.
- When dispensing ice from the dispenser, do not use crystal ceramics.
- Do not touch the cold surfaces in the freezer compartment with wet or damp hands, when your refrigerator is in operation.
- Do not put glass containers, glass bottles or soda in the freezer.
- This appliance is not intended for use by persons (including children) with reduced physical, sensory or mental capabilities, or lack of experience and knowledge, unless they have been given supervision or instruction concerning the use of the appliance by a person responsible for their safety.
- Do not refreeze frozen food that has thawed completely. Doing so may result in a serious health issue.
- If you are throwing away your old refrigerator, make sure the CFC coolant is removed for proper disposal by a qualified servicer. If you release CFC coolant, you may be fined or imprisoned in accordance with the relevant environmental law.
- Junked or abandoned refrigerators are dangerous, even if they are sitting for only a few days. When disposing of the refrigerator, remove the packing materials from the door or take off the doors but leave the shelves in place so that children may not easily climb inside.
- If connected to a circuit protected by fuses, use time delay fuse.

### **WARNING**

This product contains chemicals known to the State of California to cause cancer and birth defects or other reproductive harm. ***Wash hands after handling.***

**READ ALL INSTRUCTIONS BEFORE USING THE APPLIANCE.**

To reduce the risk of fire, electric shock, or personal injury when using your product, basic safety precautions should be followed, including the following:

 **CAUTION****Installation**

- The refrigerator must be properly installed in accordance with the Installer Instructions that were taped to the front of the refrigerator.
- Be careful when you unpack and install the refrigerator. Immediately dispose of plastic and other packing materials out of reach of children.
- The appliance must be positioned for easy access to a power source.

**Use**

- Close the door carefully when children are around.
- Keep fingers out of pinch point areas; clearances between the doors and cabinets are necessarily small. Be careful closing doors when children are nearby.
- If you store food improperly, be aware that it may fall and cause injury.
- Do not use aerosols near the refrigerator.
- Do not store articles on the top of the appliance.
- Do not strike or apply excessive force to any glass surface. It may break.

**Maintenance**

- Do not use strong detergents like wax or thinners for cleaning. Clean with a soft cloth.
- Wipe foreign objects (such as dust and water) off the prongs of the power plug and contact areas regularly.
- Do not store, disassemble or repair the refrigerator by yourself.
- Remove any dust or foreign matter from the power plug pins.
- Do not use a wet or damp cloth when cleaning the plug.
- If the refrigerator is disconnected from the power supply, you should wait for at least five minutes before plugging it back in.
- If you notice a chemical or burning plastic smell or see smoke, unplug the refrigerator immediately and contact your LG Electronics Service Center.

**SAVE THESE INSTRUCTIONS**

# COMPONENTS

Use this page to become more familiar with the parts and features of your refrigerator.

\*The appearance and specifications of the actual product may differ depending on the model.

ENGLISH

## Refrigerator Exterior

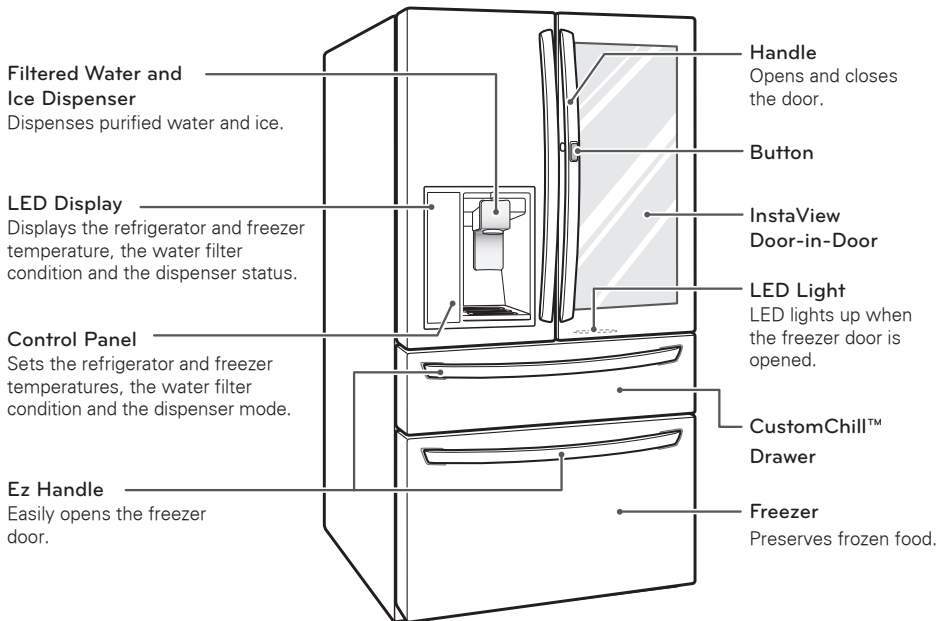

ENGLISH

## Refrigerator Interior

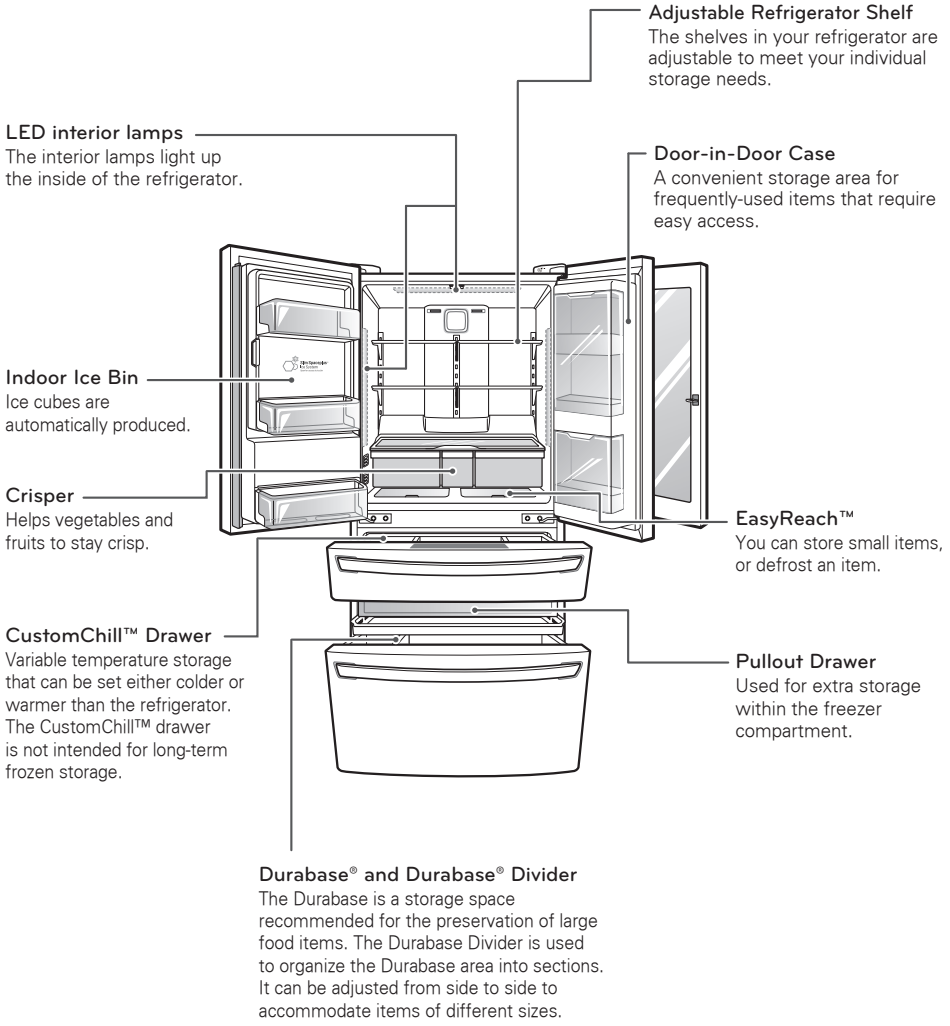



# INSTALLATION

## Installation Overview

Please read the following installation instructions first after purchasing this product or transporting it to another location.

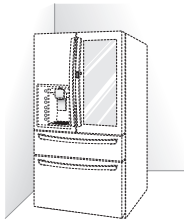

1 Unpacking your refrigerator

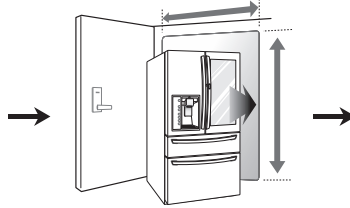

2 Choosing the proper location

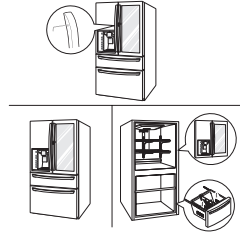

3 Disassembling/Assembling

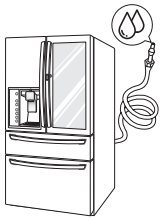

4 Connecting the water supply and water line

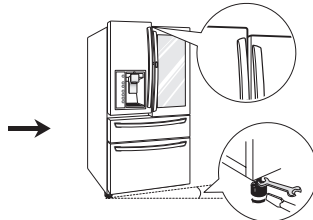

5 Leveling and Door Alignment

**NOTE**

Connect to potable water supply only.

## Specifications

The appearance and specifications listed in this manual may vary due to constant product improvements.

<b>Bottom-freezer refrigerator model LMXS30796*</b>	
<b>Description</b>	French door refrigerator
<b>Dimensions</b>	35 3/4" (W) X 39 1/8" (D) X 70 1/4" (H). 51"(D w/ door open) 908 mm (W) X 994 mm (D) X 1785 mm (H). 1295 mm (D w/ door open)
<b>Net weight</b>	404 lb. (183 kg)

<b>Bottom-freezer refrigerator model LMXC23796*</b>	
<b>Description</b>	French door refrigerator
<b>Dimensions</b>	35 3/4" (W) X 32 1/8" (D) X 70 1/4" (H). 44"(D w/ door open) 908 mm (W) X 816 mm (D) X 1785 mm (H). 1117 mm (D w/ door open)
<b>Net weight</b>	371 lb. (168 kg)

## Unpacking the Refrigerator

### WARNING

- Use two or more people to move and install the refrigerator. Failure to do so can result in back or other injury.
- Your refrigerator is heavy. When moving the refrigerator for cleaning or service, be sure to protect the floor. Always pull the refrigerator straight out when moving it. Do not wiggle or walk the refrigerator when trying to move it, as floor damage could occur.
- Keep flammable materials and vapors, such as gasoline, away from the refrigerator. Failure to do so can result in fire, explosion, or death.

Remove tape and any temporary labels from your refrigerator before using. Do not remove any warning-type labels, the model and serial number label, or the Tech Sheet that is located under the front of the refrigerator.

To remove any remaining tape or glue, rub the area briskly with your thumb. Tape or glue residue can also be easily removed by rubbing a small amount of liquid dish soap over the adhesive with your fingers. Wipe with warm water and dry.

Do not use sharp instruments, rubbing alcohol, flammable fluids, or abrasive cleaners to remove tape or glue. These products can damage the surface of your refrigerator.

Refrigerator shelves are installed in the shipping position. Please reinstall shelves according to your individual storage needs.

## Choosing the Proper Location

- Select a place where a water supply can be easily connected for the automatic icemaker.

### NOTE

The water pressure must be 20~120 psi or 138~827 kPa or 1.4~8.4 kgf/cm<sup>2</sup> on models without a water filter and 40~120 psi or 276~827 kPa or 2.8~8.4 kgf/cm<sup>2</sup> on models with a water filter.

- The refrigerator should always be plugged into its own individual properly grounded electrical outlet rated for 115 Volts, 60 Hz, AC only, and fused at 15 or 20 amperes. This provides the best performance and also prevents overloading house wiring circuits which could cause a fire hazard from overheated wires. It is recommended that a separate circuit serving only this appliance be provided.

### WARNING

To reduce the risk of electric shock, do not install the refrigerator in a wet or damp area.

## Flooring

To avoid noise and vibration, the unit must be leveled and installed on a solidly constructed floor. If required, adjust the leveling legs to compensate for unevenness of the floor. The front should be slightly higher than the rear to aid in door closing. Leveling legs can be turned easily by tipping the cabinet slightly. Turn the leveling legs to the left to raise the unit or to the right to lower it. (See Leveling and Door Alignment.)

### NOTE

Installing on carpeting, soft tile surfaces, a platform or weakly supported structure is not recommended.

### Ambient Temperature

Install this appliance in an area where the temperature is between 55°F (13°C) and 110°F (43°C). If the temperature around the appliance is too low or high, cooling ability may be adversely affected.

### Measuring Clearances

Too small of a distance from adjacent items may result in lowered freezing capability and increased electricity consumption charges. Allow at least 24 inches (61 cm) in front of the refrigerator to open the doors, and at least 2 inches (5.08 cm) between the back of the refrigerator and the wall.

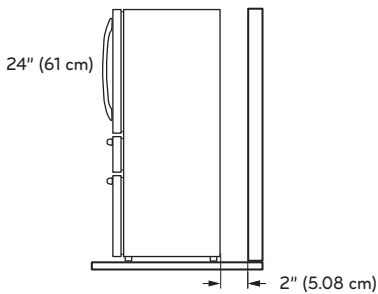

### Removing/Assembling the Refrigerator Door Handles

#### NOTE

When it is necessary to move the refrigerator through a narrow opening, removing the doors is the recommended procedure. If it is necessary to remove the handles, follow the directions below.

#### Removing the Handles

- 1 Loosen the set screws **1** with a  $\frac{3}{32}$  in. Allen wrench and remove the handle.
- 2 Loosen the mounting fasteners **2** that connect to the refrigerator door and handle using a  $\frac{1}{4}$  in. Allen wrench, and remove the mounting fasteners.

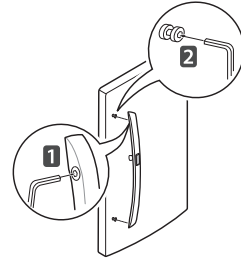

#### Assembling the Handles

- 1 Assemble the mounting fasteners **1** at both ends of the handle using a  $\frac{1}{4}$  in. Allen wrench.
- 2 Place the handle on the door by fitting the handle footprints over the mounting fasteners and tightening the set screws **2** with a  $\frac{3}{32}$  in. Allen wrench.

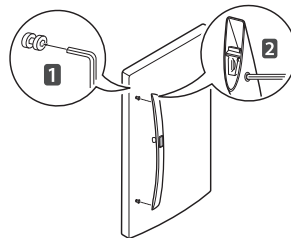

## Removing/Assembling the Freezer Drawer Handle

### Removing the Handle

- 1 Loosen the set screws **1** located on the lower side of the handle with a  $\frac{1}{8}$  in. Allen wrench and remove the handle.
- 2 Loosen the mounting fasteners **2** that connect to the freezer drawer and handle using a  $\frac{1}{4}$  in. Allen wrench, and remove the mounting fasteners.

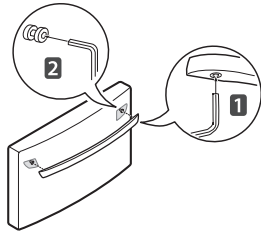

### Assembling the Handle

- 1 Assemble the mounting fasteners **1** at both ends of the handle using a  $\frac{1}{4}$  in. Allen wrench.
- 2 Place the handle on the door by fitting the handle footprints over the mounting fasteners and tightening the set screws **2** with a  $\frac{1}{8}$  in. Allen wrench.

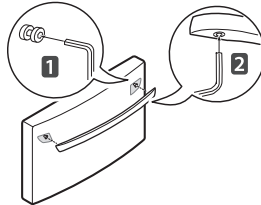

### ! WARNING

When assembling or disassembling the handle:

- Grasp the handle tightly to avoid dropping it.
- Do not swing the handle into nearby people or animals.
- Make sure that the bracket hole of the handle fits properly into the stopper bolt of the door. Assemble the set screws to fix the handle into place.
- Make sure that there is not a gap between the door and handle after assembling the handle.

## Removing/Assembling the Doors and Drawers

When it is necessary to move the refrigerator through a narrow opening, removing the doors is the recommended procedure.

### ! WARNING

- If your entrance door is too narrow for the refrigerator to pass through, remove the refrigerator doors and move the refrigerator sideways through the doorway.
- Use two or more people to remove and install the refrigerator doors. Failure to do so can result in back or other injury.
- Disconnect the electrical supply to the refrigerator before installing. Failure to do so could result in serious injury or death.
- Do not put hands, feet or other objects into the air vents or bottom of the refrigerator. You may be injured or receive an electrical shock.
- Be careful when handling the hinge and stopper, to avoid injury.
- Remove food and bins before detaching the doors and drawers.

### Removing the Left Refrigerator Door

- 1 The water supply is connected to the upper right part of the rear surface of the refrigerator. Remove the ring in the joint area. Hold the water supply connection and gently push the collet to detach the water supply line as shown in 1.

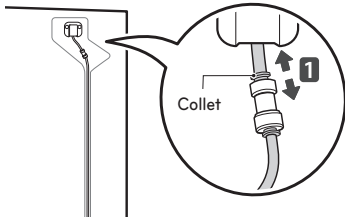

**NOTE**  
 Detachment of the water supply line is applicable only when detaching the left refrigerator door.

- 2 Remove the screw 1 from the hinge cover at the top of the refrigerator. Lift the hook (not visible), located at the bottom of the front side of the cover 2 with a flat-head screwdriver.

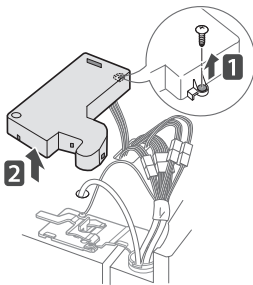

- 3 Remove the cover and pull out the tube 1. Disconnect all wire harnesses 2. Unscrew the ground wire 3.

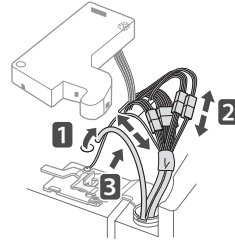

- 4 Rotate the hinge lever counterclockwise 1. Lift the top hinge 2 free of the hinge lever latch.

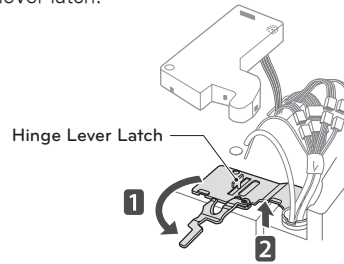

**CAUTION**  
 When lifting the hinge free of the latch, be careful that the door does not fall forward.

- 5 Lift the door from the middle hinge pin and remove the door.

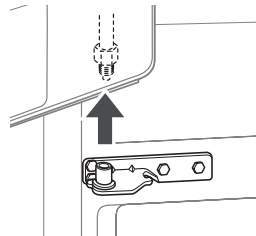

**CAUTION**  
 Place the door, inside facing up, on a non-scratching surface.

### Removing the Right Refrigerator Door

- 1 Remove the top hinge cover screw **1**. Lift the hook (not visible), located at the bottom of the front side of the cover **2**, with a flat-head screwdriver.

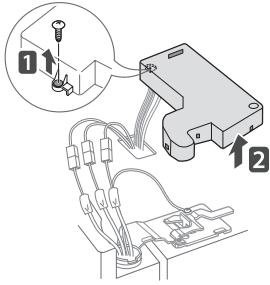

- 2 Detach the wire harnesses **1**. Unscrew the ground wire **2**.

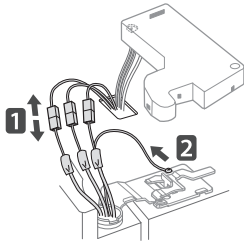

- 3 Rotate the hinge lever **1** clockwise. Lift the top hinge **2** free of the hinge lever latch.

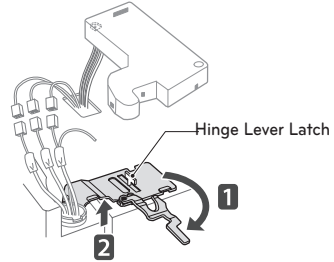

**CAUTION**

When lifting the hinge free of the hinge lever latch, be careful that the door does not fall forward.

- 4 Lift the door from the middle hinge pin and remove the door.

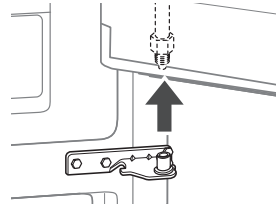

**CAUTION**

Place the door, inside facing up, on a non-scratching surface.

ENGLISH

### Assembling the Right Refrigerator Door

Install the right-side door first.

- 1 Make sure that the plastic sleeve is inserted in the bottom of the door. Lower the door onto the middle hinge pin as shown in the figure.

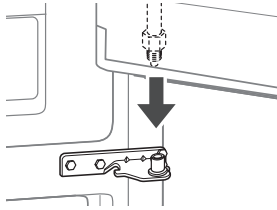

- 2 Fit the hinge **1** over the hinge lever latch and slot it into place. Rotate the lever **2** counterclockwise to secure the hinge.

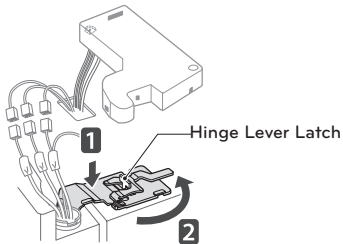

- 3 Connect the wire harnesses **1**. Screw the ground wire **2**.

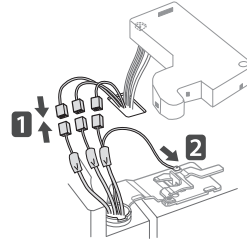

- 4 Make sure that the door-switch located inside the cover is tightly connected. Position the cover in its place. Insert and tighten the cover screw **2**.

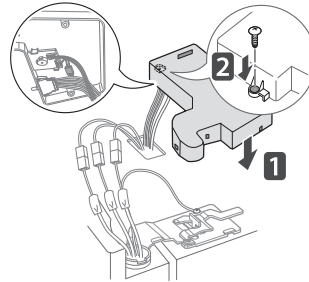



### Assembling the Left Refrigerator Door

Install the left refrigerator door after the right door is installed.

- 1 Make sure that the plastic sleeve is inserted in the bottom of the door. Install the refrigerator door onto the middle hinge.

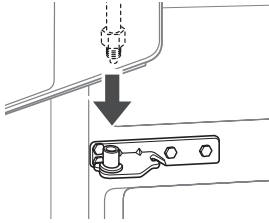

- 2 Fit the hinge **1** over the hinge lever latch and slot it into place. Rotate the lever clockwise **2** and fasten the hinge.

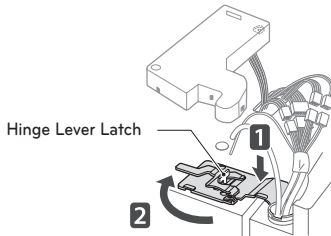

- 3 Connect all the wire harnesses.

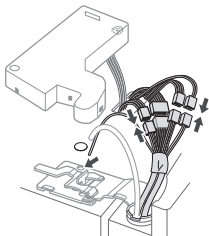

- 4 Push the water supply tube into the hole on the top case and pull it through the backplate.

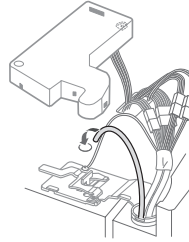

- 5 Hold the water supply connection and gently push in the collet to connect the water supply line as shown in **1**. Insert the tube at least  $\frac{5}{8}$  inch (15 mm) into the connector.

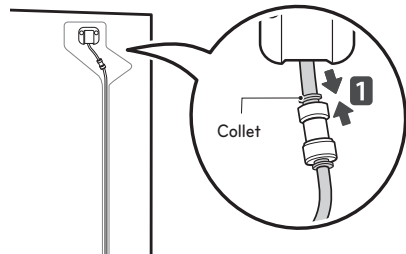

- 6 Screw the ground wire **1**. Make sure that the door-switch located inside the cover is tightly connected. Place the cover **2** in its position and tighten the cover screw **3**.

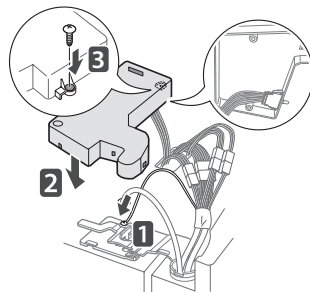

**NOTE**

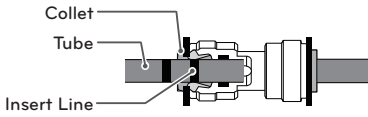

- 1) Gently insert the tube until only one line shows on the tube.

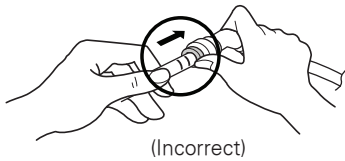
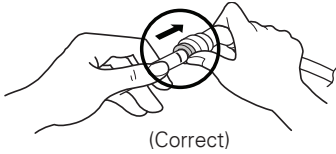

- 2) Pull the tube to make sure that the tube is tightly fastened.

**Removing the CustomChill™ Drawer**

- 1 Pull the drawer open to full extension. Remove the basket by lifting the basket from the rail system.

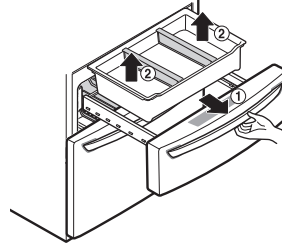

**NOTE**

Before removing the CustomChill™ drawer, it must be disconnected from the temperature control.

- 2 Disconnect the wire harness connection at the end of the right rail by pressing on the tabs on either side. It may help to use a small, flat-blade screwdriver to apply pressure to the ends of the tabs on either side.

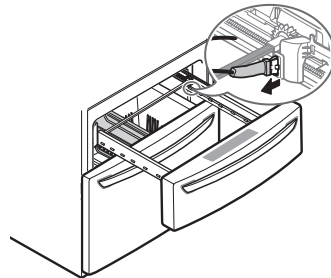

- 3 Hold both sides of the door and lift it to remove it from the rail system.

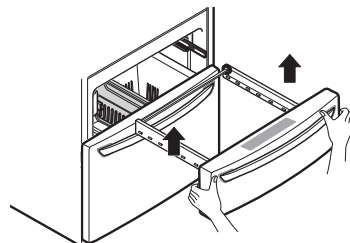

### Assembling the CustomChill™ Drawer

- 1 Grasp the door on each side and lower it into place on the rail system.

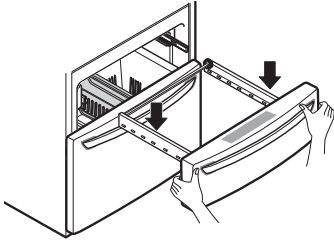

- 2 Reconnect the wire harness to the connection at the end of the right rail by aligning the two ends and pushing them together until you hear a click. The tabs should snap back into place. Tug gently to make sure the connection is secure.

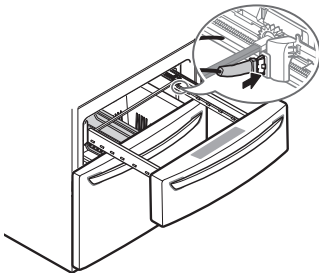

**NOTE**  
If you do not reconnect the wire harness securely, the CustomChill™ drawer will not work properly.

- 3 Pull the drawer open to full extension. Lower the basket onto the rail system.

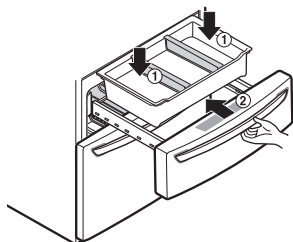

### Removing the Freezer Drawer

**CAUTION**

- Use two or more people to remove and install the freezer drawer. Failure to do so can result in back or other injury.
- Do not hold the handle when removing or replacing the drawer. The handle may come off, causing personal injury.
- Be careful of sharp hinges on both sides of the drawer.
- When you lay the drawer down, be careful not to damage the floor.
- Do not sit or stand on the freezer drawer.
- To prevent accidents, keep children and pets away from the drawer. Do not leave the drawer open.

- 1 Pull the freezer drawer open to full extension.
- 2 Remove the top pullout drawer by first pulling the drawer open to full extension.

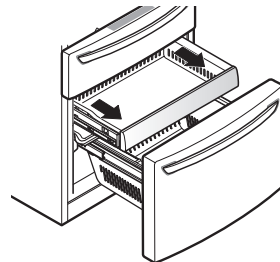

On the left rail, use a flat blade screwdriver to push in on the tab to release the drawer from the rail, as shown below. Once the left side is loose, push the tab on the right side with your finger to release the drawer. Lift the front of the drawer up, then pull it straight out.

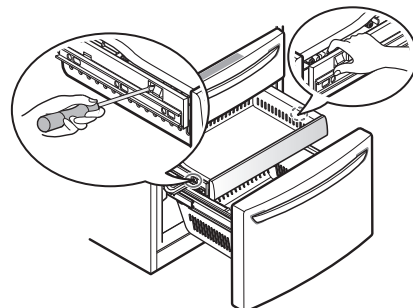

- 3 Remove the middle drawer by pulling the drawer out to full extension. Lift the front of the drawer up, then pull it straight out.

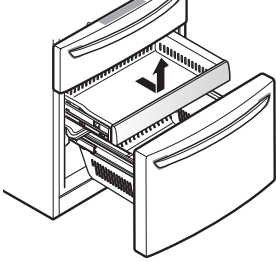

- 4 Remove the Durabase by opening the freezer drawer to full extension and lifting the basket off of the rail assembly.

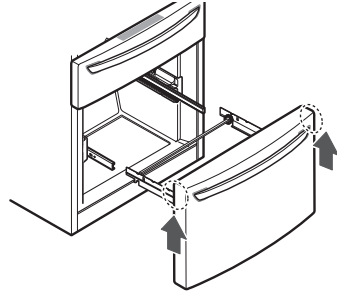

- 5 Remove the screws from the rails at both ends.

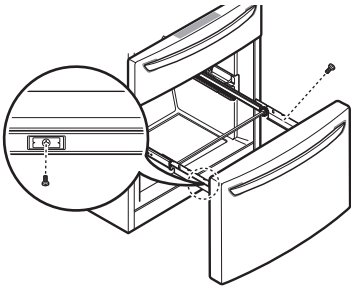

- 6 With both hands, grip both sides of the drawer and pull it up to remove it from the rails.

**CAUTION**

Do not hold the handle when removing or replacing the drawer. The handle may come off and it could cause personal injury.

- 7 With both hands, hold each rail and push them in simultaneously.

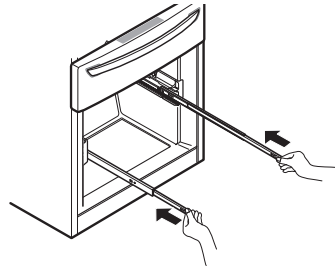

### Assembling the Freezer Drawer

- 1 With both hands, pull out each rail simultaneously until both rails are fully extended.

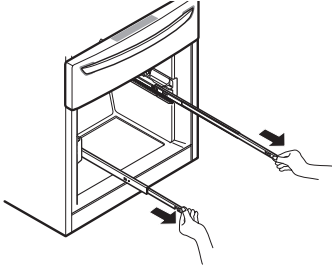

- 2 Grasp the drawer on each side and hook the drawer supports into the rail tabs located on both sides.

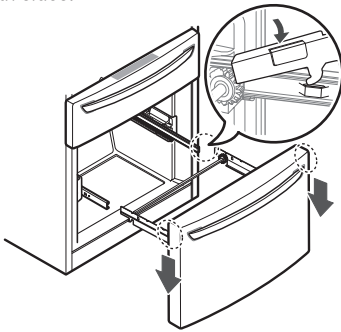

**CAUTION**  
Do not hold the handle when removing or replacing the drawer. The handle may come off and it could cause personal injury.

- 3 Lower the door into final position and tighten the screws located on both sides.

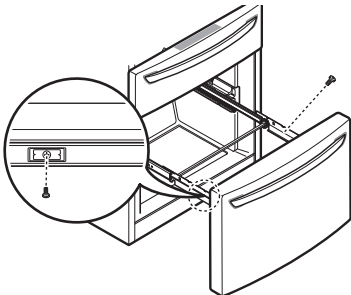

- 4 Insert the the top pullout drawer into the frame, and push the drawer back into place until you hear a click.

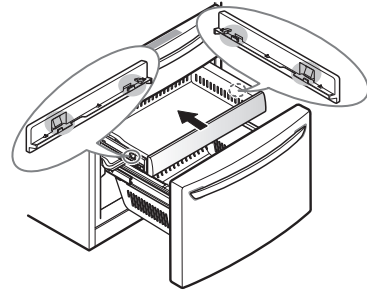

- 5 Slightly tilt up the front of the middle drawer, insert the drawer into the frame, and push it back into place.

- 6 Insert the lower basket in the rail assembly.

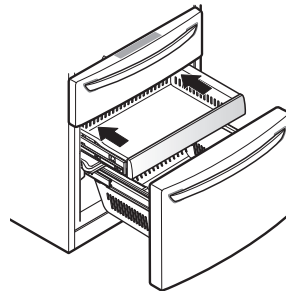

## Connecting the Water Line

### Before You Begin

This water line installation is not covered by the refrigerator warranty. Follow these instructions carefully to minimize the risk of expensive water damage.

Water hammer (water banging in the pipes) in house plumbing can cause damage to refrigerator parts and can lead to water leakage or flooding. Call a qualified plumber to correct water hammer before installing the water supply line to the refrigerator.



#### CAUTION

To prevent burns and product damage, only connect the refrigerator water line to a cold water supply.

If you use your refrigerator before connecting the water line, make sure the icemaker power switch is in the OFF (O) position.



#### CAUTION

Do not install the icemaker tubing in areas where temperatures fall below freezing.

### Water Pressure

The water pressure must be 20~120 psi or 138~827 kPa or 1.4~8.4 kgf/cm<sup>2</sup> on models without a water filter and 40~120 psi or 276~827 kPa or 2.8~8.4 kgf/cm<sup>2</sup> on models with a water filter.

If a reverse osmosis water filtration system is connected to your cold water supply, this water line installation is not covered by the refrigerator warranty. Follow the instructions carefully to minimize the risk of expensive water damage.

If a reverse osmosis water filtration system is connected to your cold water supply, the water pressure to the reverse osmosis system needs to be a minimum of 40 to 60 psi (276~414 kPa or 2.8~4.2 kgf/cm<sup>2</sup>, less than 2.0~3.0 sec. to fill a cup of 7 oz or 198 cc capacity).



#### CAUTION

Wear eye protection during installation to prevent injury.

If the water pressure from the reverse osmosis system is less than 20 psi or 138 kPa or 1.4 kgf/cm<sup>2</sup> (takes more than 4.0 sec to fill a cup of 7 oz or 198 cc capacity):

- Check to see if the sediment filter in the reverse osmosis system is blocked. Replace the filter if necessary.
- Allow the storage tank on the reverse osmosis system to refill after heavy usage.
- If the issue concerning water pressure from reverse osmosis remains, call a licensed, qualified plumber.
- All installations must be in accordance with local plumbing code requirements.

### What You Will Need

- **Copper Tubing**, ¼ in. outer diameter, to connect the refrigerator to the water supply. Be sure both ends of the tubing are cut square.
- To determine how much tubing you need: measure the distance from the water valve on the back of the refrigerator to the water supply pipe. Then, add 8 feet (2.4 m). Be sure there is sufficient extra tubing (about 8 feet [2.4 m] coiled into 3 turns of about 10 in. [25 cm] diameter) to allow the refrigerator to move out from the wall after installation.

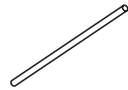

- **Power drill.**
- **½ in. or adjustable wrench.**

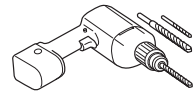

- **Flat blade and Phillips head screwdrivers.**

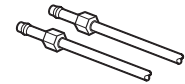

- **Two ¼ in. outer diameter compression nuts and 2 ferrules (sleeves)** to connect the copper tubing to the shutoff valve and the refrigerator water valve.

- If your existing copper water line has a flared fitting at the end, you will need an adapter (available at plumbing supply stores) to connect the water line to the refrigerator OR you can cut off the flared fitting with a tube cutter and then use a compression fitting.

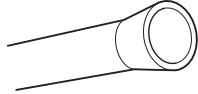

- **Shutoff valve** to connect to the cold water line. The shutoff valve should have a water inlet with a minimum inside diameter of 5/32 in. at the point of connection to the COLD WATER LINE. Saddle-type shutoff valves are included in many water supply kits. Before purchasing, make sure a saddle-type valve complies with your local plumbing codes.

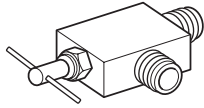

**NOTE**  
A self piercing saddle type water valve should not be used.

**Water Line Installation Instructions**

**WARNING**  
When using any electrical device (such as a power drill) during installation, be sure the device is battery powered, double insulated or grounded in a manner that will prevent the hazard of electric shock.

Install the shutoff valve on the nearest frequently used drinking water line.

- 1 **SHUT OFF THE MAIN WATER SUPPLY**  
Turn on the nearest faucet to relieve the pressure on the line.

- 2 **CHOOSE THE VALVE LOCATION**  
Choose a location for the valve that is easily accessible. It is best to connect into the side of a vertical water pipe. When it is necessary to connect into a horizontal water pipe, make the connection to the top or side, rather than at the bottom, to avoid drawing off any sediment from the water pipe.

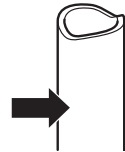

- 3 **DRILL THE HOLE FOR THE VALVE**  
Drill a 1/4 in. hole in the water pipe using a sharp bit. Remove any burrs resulting from drilling the hole in the pipe. Be careful not to allow water to drain into the drill. Failure to drill a 1/4 in. hole may result in reduced ice production or smaller cubes.

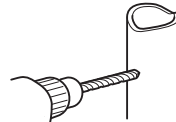

**NOTE**  
The hookup line cannot be white, plastic tubing. Licensed plumbers must use only copper tubing (NDA tubing #49595 or #49599) or Cross Link Polyethylene (PEX) tubing.

4 FASTEN THE SHUTOFF VALVE

Fasten the shutoff valve to the cold water pipe with the pipe clamp.

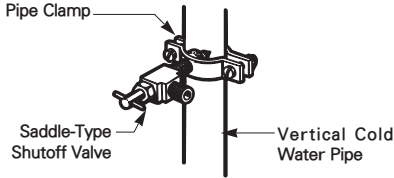

**NOTE**

Commonwealth of Massachusetts Plumbing Codes 248CMR shall be adhered to. Saddle valves are illegal and their use is not permitted in Massachusetts. Consult with the licensed plumber.

5 TIGHTEN THE PIPE CLAMP

Tighten the clamp screws until the sealing washer begins to swell.

**NOTE:** Do not overtighten the clamp or you may crush the tubing.

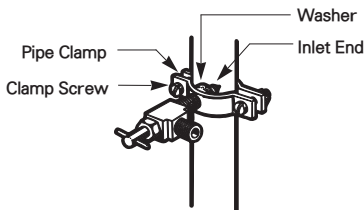

6 ROUTE THE TUBING

Route the tubing between the cold water line and the refrigerator.

Route the tubing through a hole drilled in the wall or floor (behind the refrigerator or adjacent base cabinet) as close to the wall as possible.

**NOTE**

Be sure there is sufficient extra tubing (about 8 feet coiled into 3 turns of about 10 in. diameter) to allow the refrigerator to move out from the wall after installation.

7 CONNECT THE TUBING TO THE VALVE

Place the compression nut and ferrule (sleeve) for the copper tubing onto the end of the tubing and connect it to the end of the tubing and connect it to the shutoff valve. Make sure the tubing is fully inserted into the valve. Tighten the compression nut securely.

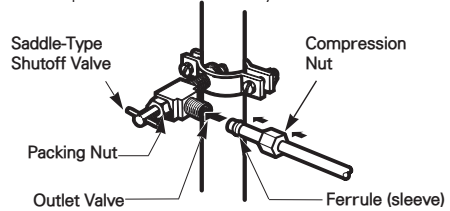

8 FLUSH OUT THE TUBING

Turn the main water supply on and flush out the tubing until the water is clear.

Shut the water off at the water valve after about one quart of water has been flushed through the tubing.



9 CONNECT THE TUBING TO THE REFRIGERATOR

**NOTE:** Before making the connection to the refrigerator, be sure that the refrigerator power cord is not plugged into the wall outlet.

- a. Remove the plastic flexible cap from the water valve.
- b. Place the compression nut and ferrule (sleeve) onto the end of the tubing as shown.
- c. Insert the end of the copper tubing into the connection as far as possible. While holding the tubing, tighten the fitting.

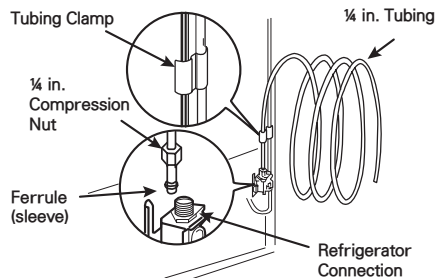



**10 TURN THE WATER ON AT THE SHUTOFF VALVE**

Tighten any connections that leak.

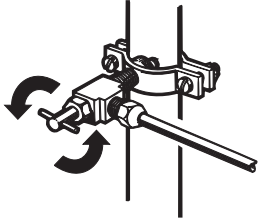

**CAUTION**

Check to see if leaks occur at the water line connections.

**11 PLUG IN THE REFRIGERATOR**

Arrange the coil of tubing so that it does not vibrate against the back of the refrigerator or against the wall. Push the refrigerator back to the wall.

**12 START THE ICEMAKER**

Set the icemaker power switch to the **ON** position.

The icemaker will not begin to operate until it reaches its operating temperature of 15°F (-9°C) or below. It will then begin operation automatically if the icemaker power switch is in the **ON (I)** position.

**Turning On The Power**

Plug in the refrigerator.

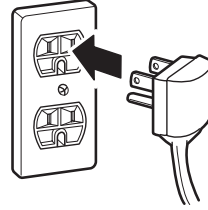

**CAUTION**

- Connect to a rated power outlet.
- Have a certified electrician check the wall outlet and wiring for proper grounding.
- Do not damage or cut off the ground terminal of the power plug.

## Leveling and Door Alignment

### Leveling

After installing, plug the refrigerator's power cord into a 3-prong grounded outlet and push the refrigerator into the final position.

The refrigerator has two front leveling legs—one on the right and one on the left. Adjust the legs to alter the tilt from front-to-back or side-to-side. If the refrigerator seems unsteady, or you want the doors to close more easily, adjust the refrigerator's tilt using the instructions below:

- 1 Turn the leveling leg to the left to raise that side of the refrigerator or to the right to lower it. It may take several turns of the leveling leg to adjust the tilt of the refrigerator.

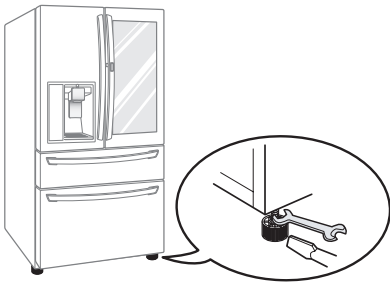

#### NOTE

A flare nut wrench works best, but an open-end wrench will suffice. Do not over-tighten.

- 2 Open both doors again and check to make sure that they close easily. If the doors do not close easily, tilt the refrigerator slightly more to the rear by turning both leveling legs to the left. It may take several more turns, and you should turn both leveling legs the same amount.

### Door Alignment

The left refrigerator door has an adjustable nut, located on the bottom hinge, to raise and lower the door for proper alignment.

If the space between the doors is uneven, follow the instructions below to align the doors:

Use the wrench (included with the owner's manual) to turn the nut in the door hinge to adjust the height. Turn to the right to raise or to the left to lower the height.

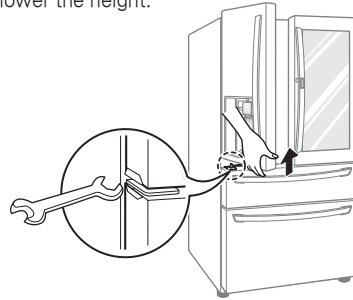

The right refrigerator door does not have an adjustable nut.

If the space between the doors is uneven, follow the instructions below to align the right door:

- 1 With one hand, lift up both the inner and outer door sections of the right door to raise them at the middle hinge. (Opening the door may make lifting it easier)
- 2 With the other hand, use pliers to insert the snap ring on the middle hinge of the inner door section as shown. Do not insert the ring on the hinge of the outer door section.
- 3 Insert additional snap rings until the right door is aligned. (Two snap rings are provided with the unit.)

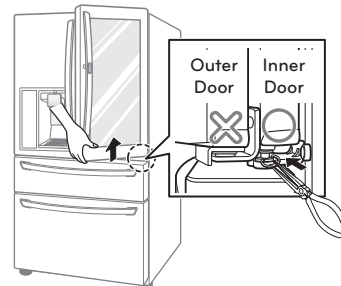

# HOW TO USE

## Before use



### Clean the refrigerator.

Clean your refrigerator thoroughly and wipe off all dust that accumulated during shipping.



#### CAUTION

- Do not scratch the refrigerator with a sharp object or use a detergent that contains alcohol, a flammable liquid or an abrasive when removing any tape or adhesive from the refrigerator.
- Do not peel off the model or serial number label or the technical information on the rear surface of the refrigerator.



#### NOTE

Remove adhesive residue by wiping it off with your thumb or dish detergent.



### Open refrigerator doors and freezer drawers to ventilate the interior.

The inside of the refrigerator may smell like plastic at first. Remove any adhesive tape from inside the refrigerator and open the refrigerator doors and the freezer drawers for ventilation.

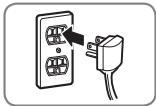

### Connect the power supply.

Check if the power supply is connected before use.  
Read the "Turning On The Power" section.

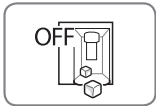

### Turn off the icemaker if the refrigerator is not yet connected to the water supply.

Turn off the automatic icemaker and then plug the power plug of the refrigerator into the grounded electrical outlet.

\* This is applicable only to certain models.



#### CAUTION

Running the automatic icemaker before connecting it to the water supply may cause the refrigerator to malfunction.



### Wait for the refrigerator to cool.

Allow your refrigerator to run for at least two to three hours before putting food in it. Check the flow of cold air in the freezer compartment to ensure proper cooling.



#### CAUTION

Putting food in the refrigerator before it has cooled could cause the food to spoil, or a bad odor could linger inside the refrigerator.

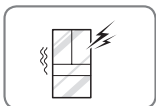

### The refrigerator makes a loud noise after initial operation.

This is normal. The volume will decrease as the temperature lowers.

## Control Panel

\* Depending on the model, some of the following functions may not be available.

### Control Panel Features

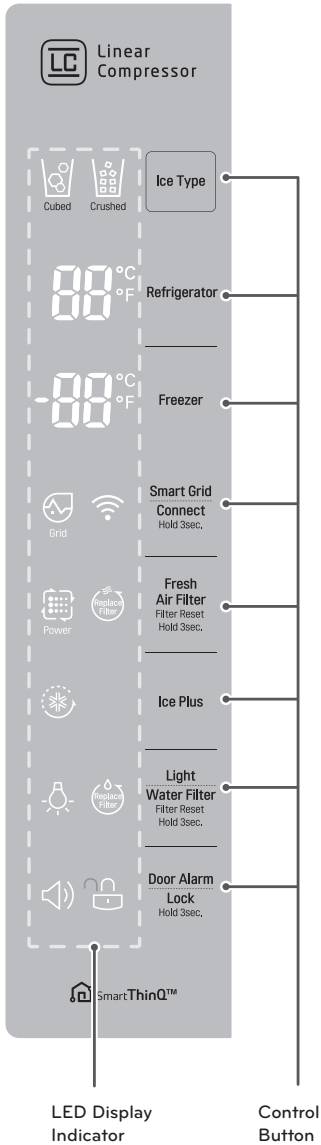

**Ice Type** Cubed Crushed

Press the Ice Type button to choose either cubed or crushed ice. The cubed or crushed ice icon will illuminate.

**Refrigerator Temperature**

Indicates the set temperature of the refrigerator compartment in Celsius (°C) or Fahrenheit (°F). The default temperature for the refrigerator is 37°F.

**Freezer Temperature**

Indicates the set temperature of the freezer compartment in Celsius (°C) or Fahrenheit (°F). The default temperature for the freezer is 0°F.

To change the temperature mode from °F to °C (or vice versa) press and hold the Refrigerator and Freezer temperature buttons simultaneously for approximately five seconds. The temperature indication on the display window switches between Celsius and Fahrenheit.

**NOTE**

The displayed temperature is the target temperature, and not the actual temperature of the refrigerator. The actual refrigerator temperature depends on the food inside the refrigerator.

**Fresh Air Filter** (On some models)

The Fresh Air Filter helps remove odors from the refrigerator. The Fresh Air Filter has two settings, Auto and Power(PWR). In Auto mode, the Fresh Air Filter will cycle on and off in increments of ten minutes on and 110 minutes off. If set to the Power(PWR) mode, the Fresh Air Filter will stay on continuously for four hours, cycling on and off in increments of ten minutes on and five minutes off. After four hours, the Fresh Air Filter will switch back to Auto mode.

- Press the Fresh Air Filter button once for Power(PWR) mode.
- Press the Fresh Air Filter button again to switch back to Auto mode.

## Control Panel Features (continued)

### Change Filter (On some models)

When the Change Filter icon turns on, the air filter needs to be replaced. After replacing the air filter, press and hold the Fresh Air Filter button for three seconds to turn the icon light off. Change the air filter approximately every 6 months.

### Ice Plus

This function increases both ice making and freezing capabilities.

- When you touch the **Ice Plus** button, the graphic will illuminate in the display and will continue for 24 hours. The function will automatically shut off after 24 hours.
- You can stop this function manually by touching the button one more time.

### Light

When you press the Light button, the dispenser light will turn on and the indicator will appear on the LED display.

### Change Water Filter

When the Water Filter indicator turns on, you need to change the water filter. After changing the water filter, press and hold the Change Filter button for three seconds to turn the indicator light off. Change the water filter approximately every six months.

## Door Alarm

- When power is connected to the refrigerator, the door alarm is initially set to ON. When you press the **Alarm** button, the display will change to OFF and the **Door Alarm** function will deactivate.
- When either the refrigerator or the freezer door is left open for more than 60 seconds, the alarm tone will sound to let you know that the door is open.
- When you close the door, the door alarm will stop.

## Lock

**The Lock function disables every other button on the display.**

- When power is initially connected to the refrigerator, the **Lock** function is off.
- If you want to activate the **Lock** function to lock other buttons, press and hold the **Lock** button for three seconds or more. The **Lock** icon will display and the **Lock** function is now enabled.
- To disable the **Lock** function, press and hold the **Lock** button for approximately three seconds.

## Connect

The Connect button, when used with the LG Smart Refrigerator smart phone app, allows the refrigerator to connect to your home's Wi-Fi network. Refer to the following page for information on the initial setup of the application.

The Connect icon allows you to check the status of the refrigerator's network connection. When the refrigerator is connected to the network, the Connect icon is illuminated.

Press and hold the Connect button for 3 seconds to connect to the network. The icon will blink while the connection is being made, then turn on once the connection is successfully made. To disconnect, press and hold the button again.

## Smart Grid

Press the Smart Grid button to turn the Smart Grid function On/Off. When the function is on, the icon will illuminate. The Smart Grid function automatically turns on when the refrigerator is connected to the Wi-Fi network.

When the refrigerator is responding to a Demand Response (DR) message from the electric company, the Grid text will illuminate.

## Power Saving Mode

- When the refrigerator is in the **Power Saving Mode**, the display will remain off until a door is opened or a button is pressed. Once on, the display will remain on for 20 seconds.

### CAUTION

#### Display Mode (For Store Use Only)

The Display Mode disables all cooling in the refrigerator and freezer sections to conserve energy while on display in a retail store. When activated, OFF will display on the control panel and the display will remain on for 20 seconds.

#### To deactivate / activate:

With either refrigerator door opened, press and hold the Refrigerator and Ice Plus buttons at the same time for five seconds. The control panel will beep and the temperature settings will display to confirm that Display Mode is deactivated. Use the same procedure to activate the Display Mode.

## Smart Features

To use the Smart Features on the refrigerator, you will need the following devices and apps:

1. a wireless router and home Wi-Fi network
2. the LG Smart Grid refrigerator
3. an Android-based smart phone
4. the LG Smart Refrigerator app from the Google Play Store.

### NOTE

To use the Smart Grid feature, you must also register for the Smart Grid (Demand Response) service with your local electric utility company. The company must provide Demand Response service.

## Setting Up the Smart App and Connecting the Refrigerator

- 1 Create an account at Smart ThinQ.  
<https://us.smartthinq.com/>  
You will use the ID and password from this account in the smart phone application.
- 2 Download the smart phone app from the Google Play Store. (LG Smart Refrigerator app)
- 3 In the app, select the Smart Model.
- 4 Log in to the app using the Smart ThinQ ID and password created in step 1.
- 5 When prompted, select the Non-Touch Screen Model.
- 6 Choose your home wireless router from the list of routers in the app. Your refrigerator and smart phone must both be connected to the same Wi-Fi network.
- 7 If necessary, enter the password for your router and click the connect button in the app.
- 8 Make sure the refrigerator display is active by pressing any button. Press and hold the Smart Grid button on the refrigerator for three seconds. The Connect LED should blink while the connection is being made.

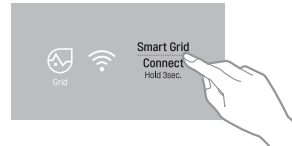

- 9 The app will automatically go through the process of registering your product on the network, using the information you've provided. This may take some time, and the Connect LED will continue to blink during this process. After the registration process is completed, a message is displayed and the app will proceed to the Home screen.
- 10 Check that the Connect LED is illuminated to confirm that the Wi-Fi network is connected. You can now use the app to control the Smart Features on your refrigerator.

### NOTE

You must connect the refrigerator to the internet using a wireless router on your home network. Tethering to a mobile phone, hotspot, or an unsecured network, for example, will cause unstable functionality.

## LG Smart Refrigerator App - What's Included

### Food Manager

Allows you to keep track of items in your refrigerator and freezer, so you can be alerted when they are near their use-by dates, generate grocery lists, and link to related recipes.

### Recipes

Features recipes from the Food Channel, searchable by ingredient, course, cuisine, total time required, and the food in your refrigerator (if entered in the Food Manager). Automatically makes grocery lists from chosen recipes.

### Grocery

Makes and manages grocery lists from items in your refrigerator or recipes.

### Refrigerator Manager

Allows you to control the refrigerator and freezer temperature settings, air filter, water filter, Ice Plus, Smart Saving, and Energy Monitoring from your smart phone.

### Smart Diagnosis

Allows you to diagnose and troubleshoot problems with your refrigerator.

### Settings

Allows you to set various options on the refrigerator and in the app.

## Smart Grid Function

When the refrigerator operates in Smart Grid mode, the Smart Refrigerator function can control energy usage or delay the operation of some functions to save energy during peak usage periods.

- You can override the Smart Grid function at any time (using the Smart Grid button or application).
- To use the Smart Grid function, you need to register the appliance with your electric utility company.

## Using the Smart Grid Function

This feature responds to notification events from your utility company to run high energy-consuming tasks during off-peak periods when demand is lower. These notification events are known as Demand Response signals.

If the refrigerator receives a Demand Response signal from the utility company, the refrigerator will turn on the Grid LED on the refrigerator display and control its power consumption according to the signal.

The refrigerator will respond to the signals received from the utility company as long as product performance is maintained.

If the refrigerator receives a Demand Response signal, the refrigerator will operate in Delay Appliance Load (DAL) or Temporary Appliance Load Reduction (TALR) mode.

**Delay Appliance Load (DAL):** The refrigerator responds to a DAL signal by providing a moderate load reduction for the duration of the delay period. This mode controls functions that consume a lot of energy such as adjusting the cooling system, running the defrost cycle, and making ice.

- When the refrigerator operates in DAL mode, the Grid LED is illuminated on the refrigerator display.
- DAL mode is automatically deactivated after it lasts for the amount of time stipulated by the DAL signal (max. 4 hours) or when you override the Smart Grid function.

### Temporary Appliance Load Reduction (TALR) :

The refrigerator responds to a TALR signal by aggressively reducing the load for a short time period, typically 10 minutes. This mode reduces energy consumption by stopping the compressor and controlling the functions that consume a lot of energy such as the defrost cycle and fan.

- When the refrigerator operates in TALR mode, the Grid LED is illuminated on the refrigerator display.
- TALR mode is automatically deactivated after it lasts for the received duration (max. 10 minutes), or when you override the Smart Grid function. The mode is immediately deactivated and the refrigerator returns to its normal state when the door is opened or closed, or the dispenser is used.



## Smart Features (continued)

### Override Smart Grid Mode

If you want the refrigerator to ignore the Demand Response signal from the utility company, you can override the Smart Grid function by pushing the Smart Grid button while the refrigerator is in Smart Grid mode.

When you override the Smart Grid function, the refrigerator ignores the Demand Response signal and is no longer controlled by the utility company until the next Demand Response signal is sent.

You can also override the Smart Grid function using the smart phone app.

### Open API

#### LG Open API

You can manage Smart Grid features for the LG Smart Refrigerator.

Please check the detailed specifications on the notice page on [us.smartthing.com](http://us.smartthing.com).

#### API list :

##### Demand response

- Send demand response signal

##### Power saving

- Set saving mode
- Get schedule of DR/Delay Defrost

##### Energy monitoring

- Get setting temperature
- Get door open event
- Get energy consumption

##### Delay defrost capability

- Insert a delay defrost schedule event
- Update a delay defrost schedule event
- Delete a delay defrost schedule event
- Get the delay defrost schedule

## Smart Grid Application Features

### 1 Smart Saving\_Demand Response

You can lower energy usage based on Demand Response (DR) signals from the utility company.

If the refrigerator is operating in Smart Saving mode according to the DR signal, you can see a pop up.

#### Smart Saving\_Delay Defrost

Lower energy usage based on time period.

### 2 Energy monitoring

The refrigerator can check number of door openings and power consumption.

### 3 Remote Control

You can control the Refrigerator Temperature, Fresh Air Filter and Ice Plus from the smart phone app.

### 4 Push messages.

- When the door is open over ten minutes, you will receive a push message.
- When Ice Plus is finished, you will receive a push message.

## Open Source Software Notice

### Information

To obtain the source code under GPL, LGPL, MPL, and other open source licenses, that is contained in this product, please visit <http://opensource.lge.com>. In addition to the source code, all referred license terms, warranty disclaimers and copyright notices are available for download.

LG Electronics will also provide open source code to you on CD-ROM for a charge covering the cost of performing such distribution (such as the cost of media, shipping, and handling) upon email request to [opensource@lge.com](mailto:opensource@lge.com). This offer is valid for three (3) years from the date on which you purchased the product.

### FCC Notice (For transmitter module contained in this product)

This equipment has been tested and found to comply with the limits for a Class B digital device, pursuant to Part 15 of the FCC Rules. These limits are designed to provide reasonable protection against harmful interference in a residential installation. This equipment generates, uses, and can radiate radio frequency energy and, if not installed and used in accordance with the instructions, may cause harmful interference to radio communications. However, there is no guarantee that interference will not occur in a particular installation. If this equipment does cause harmful interference to radio or television reception, which can be determined by turning the equipment off and on, the user is encouraged to try to correct the interference by one or more of the following measures:

- Reorient or relocate the receiving antenna.
- Increase the separation between the equipment and the receiver.
- Connect the equipment to an outlet on a circuit different from that to which the receiver is connected.
- Consult the dealer or an experienced radio/TV technician for help.

This device complies with part 15 of the FCC Rules. Operation is subject to the following two conditions:

- 1) this device may not cause harmful interference and
- 2) this device must accept any interference received, including interference that may cause undesired operation of the device.

Any changes or modifications in construction of this device which are not expressly approved by the party responsible for compliance could void the user's authority to operate the equipment.

### FCC RF Radiation Exposure Statement

This equipment complies with FCC radiation exposure limits set forth for an uncontrolled environment. This transmitter must not be co-located or operating in conjunction with any other antenna or transmitter.

This equipment should be installed and operated with minimum distance 20 cm (7.8 inches) between the antenna and your body. Users must follow the specific operating instructions for satisfying RF exposure compliance.

### Industry Canada Statement (For transmitter module contained in this product)

This device complies with Industry Canada's licence-exempt RSSs. Operation is subject to the following two conditions:

- 1) this device may not cause interference; and
- 2) this device must accept any interference, including interference that may cause undesired operation of the device.

This Class B digital apparatus complies with Canadian ICES-003.

### IC Radiation Exposure Statement

This equipment complies with IC radiation exposure limits set forth for an uncontrolled environment. This equipment should be installed and operated with minimum distance 20 cm (7.8 inches) between the antenna & your body.

#### NOTE

The manufacturer is not responsible for any radio or TV interference caused by unauthorized modifications to this equipment. Such modifications could void the user's authority to operate the equipment.

Wireless LAN Module (LCW-003) Specifications	
Frequency Range	2412~2462 MHz
Output Power (max.)	IEEE 802.11b: 17.56 dBm IEEE 802.11g: 25.53 dBm IEEE 802.11n: 25.29 dBm

## In-Door Ice Bin

\* Depending on the model, some of the following functions may not be available.

### ! CAUTION

- Keep hands and tools out of the ice compartment door and dispenser chute. Failure to do so may result in damage or personal injury.
- The icemaker will stop producing ice when the in-door ice bin is full. If you need more ice, empty the ice bin into the extra ice bin in the freezer compartment. During use, the ice can become uneven causing the icemaker to misread the amount of ice cubes and stop producing ice. Shaking the ice bin to level the ice within it can reduce this problem.
- Storing cans or other items in the ice bin will damage the icemaker.
- Keep the ice compartment door closed tightly. If the ice compartment door is not closed tightly, the cold air in the ice bin will freeze food in the refrigerator compartment. This could also cause the icemaker to stop producing ice.
- If the ON/OFF switch on the icemaker is set to OFF for an extended period of time, the ice compartment will gradually warm up to the temperature of the refrigerator compartment. To prevent ice cubes from melting and leaking from the dispenser, ALWAYS empty the ice bin when the icemaker is set to OFF for more than a few hours.

## Detaching the In-Door Ice Bin

- 1 Gently pull the handle to open the ice compartment.

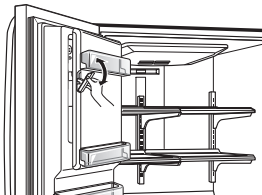

- 2 To remove the in-door ice bin, grip the front handle, slightly lift the lower part, and slowly pull out the bin as shown.

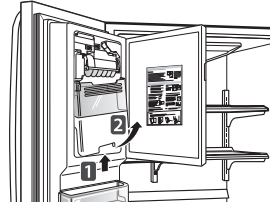

## Assembling the In-Door Ice Bin

- 1 Carefully insert the in-door ice bin while slightly slanting it to avoid contact with the icemaker.

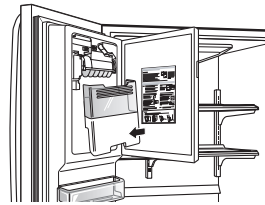

- 2 Avoid touching the ice-detecting sensor when replacing the ice bin. See the label on the ice compartment door for details.

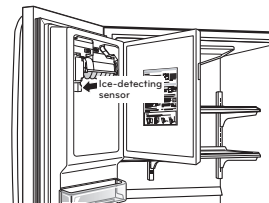

### ! CAUTION

When handling the ice bin, keep hands away from the icemaker tray area to avoid personal injury.



## Automatic Icemaker

\* Depending on the model, some of the following functions may not be available.

Ice is made in the automatic icemaker and sent to the dispenser. The icemaker will produce 70~182 cubes in a 24-hour period, depending on freezer compartment temperature, room temperature, number of door openings and other operating conditions.

- It takes about 12 to 24 hours for a newly installed refrigerator to begin making ice. Wait 72 hours for full ice production to occur.
- Ice making stops when the in-door ice bin is full. When full, the in-door ice bin holds approximately 6 to 8 (12~16 oz or 340~455 cc) glasses of ice.
- The water pressure must be 20~120 psi or 138~827 kPa or 1.4~8.4 kgf/cm<sup>2</sup> on models without a water filter and 40~120 psi or 276~827 kPa or 2.8~8.4 kgf/cm<sup>2</sup> on models with a water filter to produce the normal amount and size of ice cubes.
- Foreign substances or frost on the ice-detecting sensor can interrupt ice production. Make sure the sensor area is clean at all times for proper operation.

### ⚠ WARNING

#### Personal Injury Hazard

DO NOT place fingers or hands on the automatic ice making mechanism while the refrigerator is plugged in.

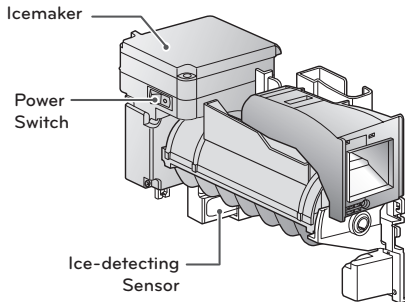

Water fills the ice tray.

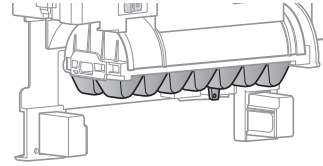

1 hour after supplying water

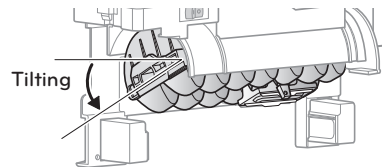

- 60 minutes after water has been added to the ice tray, the ice tray will sit slightly tilted to help the cold air reach the ice.

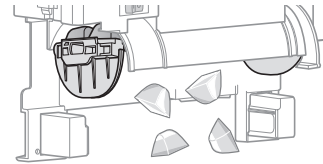

- The ice-detecting sensors will sense when the ice is ready to be dumped into the ice bin.

## Turning the Automatic Icemaker On or Off

To turn off the automatic icemaker, set the icemaker switch to **OFF (O)**. To turn on the automatic icemaker, set the switch to **ON (I)**.

## Automatic Icemaker (continued)



### CAUTION

- The first ice and water dispensed may include particles or odor from the water supply line or the water tank.
- Throw away the first few batches of ice. This is also necessary if the refrigerator has not been used for a long time.
- Never store beverage cans or other items in the ice bin for the purpose of rapid cooling. Doing so may damage the icemaker or the containers may burst.
- If discolored ice is dispensed, check the water filter and water supply. If the problem continues, contact a qualified service center. Do not use the ice or water until the problem is corrected.
- Keep children away from the dispenser. Children may play with or damage the controls.
- The ice passage may become blocked with frost if only crushed ice is used. Remove the frost that accumulates by removing the ice bin and clearing the passage with a rubber spatula. Dispensing cubed ice can also help prevent frost buildup.
- Never use thin crystal glass or crockery to collect ice. Such containers may chip or break resulting in glass fragments in the ice.
- Dispense ice into a glass before filling it with water or other beverages. Splashing may occur if ice is dispensed into a glass that already contains liquid.
- Never use a glass that is exceptionally narrow or deep. Ice may jam in the ice passage and refrigerator performance may be affected.
- Keep the glass at a proper distance from the ice outlet. A glass held too close to the outlet may prevent ice from dispensing.
- To avoid personal injury, keep hands out of the ice door and passage.
- Never remove the dispenser cover.
- If ice or water dispenses unexpectedly, turn off the water supply and contact a qualified service center.

## When You Should Turn the Icemaker Off

- When the water supply will be shut off for several hours.
- When the ice bin is removed for more than one or two minutes.
- When the refrigerator will not be used for several days.



### NOTE

The ice bin should be emptied when the icemaker on/off switch is turned to the OFF position.

## Normal Sounds You May Hear

- The icemaker water valve will buzz as the icemaker fills with water. If the power switch is in the ON (I) position, it will buzz even if it has not yet been hooked up to water. To stop the buzzing, move the power switch to OFF (O).



### NOTE

Keeping the power switch in the ON (I) position before the water line is connected can damage the icemaker.

- You will hear the sound of cubes dropping into the bin and water running in the pipes as the icemaker refills.

## Preparing for Vacation

Set the icemaker power switch to OFF (O) and shut off the water supply to the refrigerator.



### NOTE

The ice bin should be emptied anytime the icemaker on/off switch is turned to the OFF (O) position.

If the ambient temperature is expected to drop below freezing, have a qualified technician drain the water supply system to prevent serious property damage due to flooding caused by ruptured water lines or connections.

## Ice and Water Dispenser

\* Depending on the model, some of the following functions may not be available.

### ! CAUTION

Keep children away from the dispenser to prevent children playing with or damaging the controls.

### Dispenser

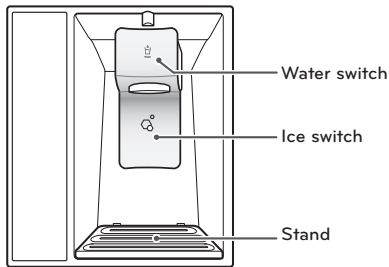

### Using the Dispenser

- To dispense **cold water**, push on the water switch with a glass.
- To dispense **ice**, push on the ice switch with a glass.

### ! NOTE

- If discolored ice is dispensed, check the water filter and water supply. If the problem continues, contact a qualified service center. Do not use the ice or water until the problem is corrected.
- The dispenser will not operate when either of the refrigerator doors are open.
- If dispensing water or ice into a container with a small opening, place it as close to the dispenser as possible.
- Some dripping may occur after dispensing. Hold your cup beneath the dispenser for a few seconds after dispensing to catch all of the drops.

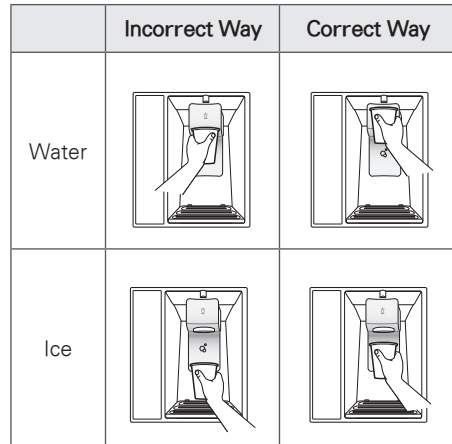

### ! CAUTION

Throw away the first few batches of ice (about 24 cubes). This is also necessary if the refrigerator has not been used for a long time.

### Locking the Dispenser

Press and hold the Alarm and Lock button simultaneously for 3 seconds to lock the dispenser and all the control panel functions. Follow the same instructions to unlock.

### Cleaning the Dispenser Stand

- 1 Grip the stand with both hands and pull it out.

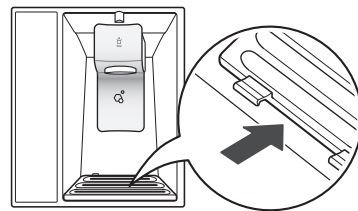

- 2 Wipe out dirty areas with a clean cloth.

## Storing Food

### Food Preservation Location

Each compartment inside the refrigerator is designed to store different types of food. Store your food in the optimal space to enjoy the freshest taste.



#### Vegetable storage (Crisper)

Preserves vegetables and fruit.



#### EasyReach™

You can store small items, or put an item to defrost.



#### Durabase®

Largest storage space in the freezer.



#### Adjustable refrigerator shelf

Adjustable shelves to meet your individual storage needs.



#### Door-in-Door

Recommended types of food to store in the Door-in-Door section are butter, margarine, cream cheese, peanut butter, ketchup, mustard, relish, etc.

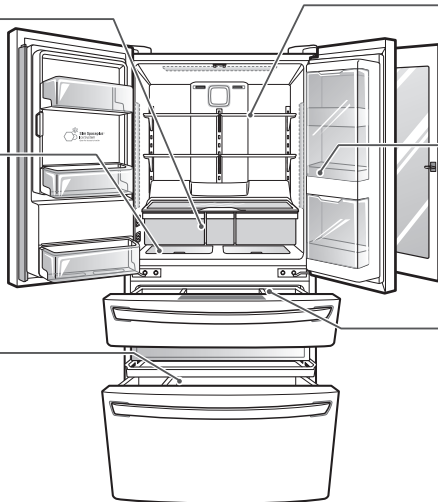

#### CustomChill™ Drawer

Adjust the temperature to store meat and seafood, cold drinks, deli snacks, or chilled wine.



### CAUTION

- Do not store food with high moisture content towards the top of the refrigerator. The moisture could come in direct contact with the cold air and freeze.
- Wash food before storing it in the refrigerator. Vegetables and fruit should be washed, and food packaging should be wiped down to prevent adjacent foods from being contaminated.
- If the refrigerator is kept in a hot and humid place, frequent opening of the door or storing a lot of vegetables in the refrigerator may cause condensation to form. Wipe off the condensation with a clean cloth or a paper towel.
- If the refrigerator door or freezer drawer is opened too often, warm air may penetrate the refrigerator and raise its temperature. It can also increase the cost to run the appliance.
- Do not overfill or pack items too tightly into door bins. Doing so may cause damage to the bin or personal injury if items are removed with excessive force.
- The temperature inside the EasyReach™ is slightly lower than in the shelf or door bin area.



### NOTE

- If you are leaving home for a short period of time, like a short vacation, the refrigerator should be left on. Refrigerated foods that are able to be frozen will stay preserved longer if stored in the freezer.
- If you are leaving the refrigerator turned off for an extended period of time, remove all food and unplug the power cord. Clean the interior, and leave the door open to prevent fungi from growing in the refrigerator.

## Food Storage Tips

\* The following tips may not be applicable depending on the model.

Wrap or store food in the refrigerator in airtight and moisture-proof material unless otherwise noted. This prevents food odor and taste transfer throughout the refrigerator. For dated products, check date code to ensure freshness.

Food	How to
<b>Butter or Margarine</b>	Keep opened butter in a covered dish or closed compartment. When storing an extra supply, wrap in freezer packaging and freeze.
<b>Cheese</b>	Store in the original wrapping until you are ready to use it. Once opened, rewrap tightly in plastic wrap or aluminum foil.
<b>Milk</b>	Wipe milk cartons. For coldest milk, place containers on interior shelf.
<b>Eggs</b>	Store in original carton on interior shelf, not on door shelf.
<b>Fruit</b>	Do not wash or hull the fruit until it is ready to be used. Sort and keep fruit in its original container, in a crisper, or store in a completely closed paper bag on a refrigerator shelf.
<b>Leafy Vegetables</b>	Remove store wrapping and trim or tear off bruised and discolored areas. Wash in cold water and drain. Place in plastic bag or plastic container and store in crisper.
<b>Vegetables with skins (carrots, peppers)</b>	Place in plastic bags or plastic container and store in crisper.
<b>Fish</b>	Store fresh fish and shellfish in the freezer section if they are not being consumed the same day of purchase. It is recommended to consume fresh fish and shellfish the same day purchased.
<b>Leftovers</b>	Cover leftovers with plastic wrap or aluminum foil, or store in plastic containers with tight lids.

## Storing Frozen Food

### ! NOTE

Check a freezer guide or a reliable cookbook for further information about preparing food for freezing or food storage times.

## Freezing

Your freezer will not quick-freeze a large quantity of food. Do not put more unfrozen food into the freezer than will freeze within 24 hours (no more than 2 to 3 lbs. of food per cubic foot of freezer space). Leave enough space in the freezer for air to circulate around packages. Be careful to leave enough room at the front so the door can close tightly.

Storage times will vary according to the quality and type of food, the type of packaging or wrap used (how airtight and moisture-proof) and the storage temperature. Ice crystals inside a sealed package are normal. This simply means that moisture in the food and air inside the package have condensed, creating ice crystals.

### ! NOTE

Allow hot foods to cool at room temperature for 30 minutes, then package and freeze. Cooling hot foods before freezing saves energy.



## Storing Frozen Food (continued)

### Packaging

Successful freezing depends on correct packaging. When you close and seal the package, it must not allow air or moisture in or out. If it does, you could have food odor and taste transfer throughout the refrigerator and could also dry out frozen food.

### Packaging recommendations:

- Rigid plastic containers with tight-fitting lids
- Straight-sided canning/freezing jars
- Heavy-duty aluminum foil
- Plastic-coated paper
- Non-permeable plastic wraps
- Specified freezer-grade self-sealing plastic bags

Follow package or container instructions for proper freezing methods.

### Do not use

- Bread wrappers
- Non-polyethylene plastic containers
- Containers without tight lids
- Wax paper or wax-coated freezer wrap
- Thin, semi-permeable wrap

## Glide'N'Access™ (on some models)

The Glide'N'Access™ slides out for easy loading of large items, like sheet cakes or deli trays, and to give you easy access to items stored at the back of the shelf.

To slide out, grasp the handle at the front of the shelf and gently pull forward. Push back to slide in.



### CAUTION

Take care when sliding the Glide'N'Access™ in and out, as taller items may fall, causing damage or injury.

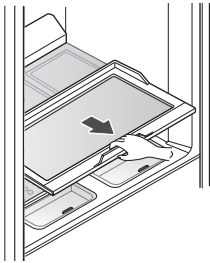

## EasyReach™ (on some models)

The EasyReach™ compartments are slightly cooler than the shelf or door bin areas, so they are a convenient place to store dairy snacks or other small items you want to keep especially cold. They are also a handy place to defrost meat.

Open and close by pulling the handle.

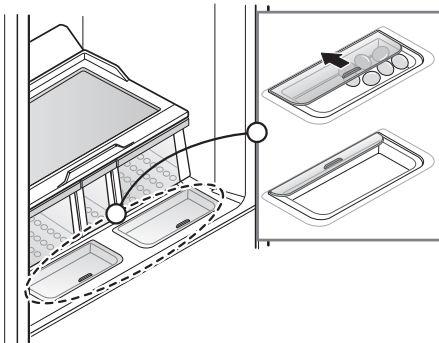

## Humidity Controlled Crisper (on some models)

Depending on the model, some of the following functions may not be available.

The crispers provide fresher tasting fruit and vegetables by letting you easily control humidity inside the drawer.

Control the amount of humidity in the moisture-sealed crispers by adjusting the control to any setting between **Vegetable** and **Fruit**.

- **Vegetable** keeps moist air in the crisper for best storage of fresh, leafy vegetables.
- **Fruit** lets moist air out of the crisper for best storage of fruit.

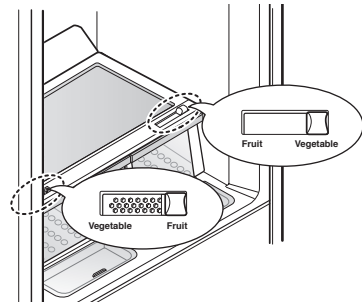

## Detaching and Assembling the Storage Bins

### Glide'N'Access™ Crisper (on some models)

To remove the Glide'N'Access™ Crisper, pull out the Crisper 1 to full extension, lift the front up, and pull straight out.

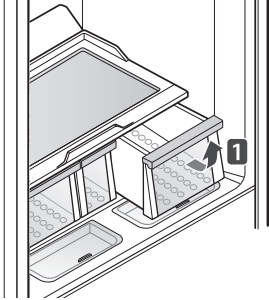

To install, slightly tilt up the front, insert the drawer into the frame and push it back into place.

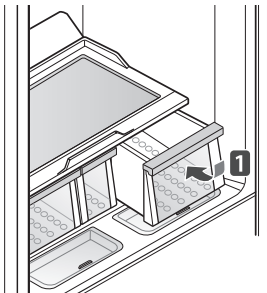

### To Remove Glide'N'Access™ (on some models)

To remove the Glide'N'Access™, pull out the shelf to full extension, lift the front up and pull straight out.

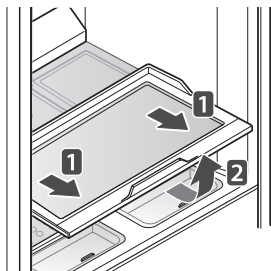

## Humidity Controlled Crisper (on some models)

To remove, pull out the Crisper 1 to full extension, lift the front up, and pull straight out.

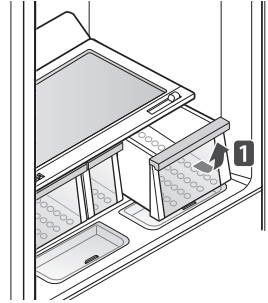

To install, slightly tilt up the front, insert the drawer into the frame and push it back into place.

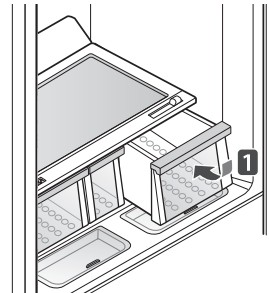

### To Remove the Glass (on some models)

(Pantry drawer not shown for clarity)

Lift up the glass under the crisper cover, and pull up and out.

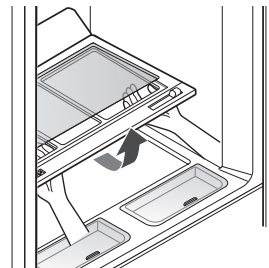

## Door Bins

The door bins are removable for easy cleaning and adjustment.

- 1 To remove the bin, simply lift the bin up and pull straight out.
- 2 To replace the bin, slide it in above the desired support and push down until it snaps into place.

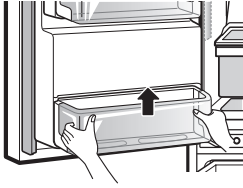

### NOTE

Some bins may vary in appearance and will only fit in one location.



### CAUTION

- Do not apply excessive force while detaching or assembling the storage bins.
- Do not use the dishwasher to clean the storage bins and shelves.
- Regularly detach and wash the storage bins and shelves; they can become easily contaminated by the food.

## InstaView Door-in-Door

The InstaView Door-in-Door compartment allows for easy access to commonly used food items.

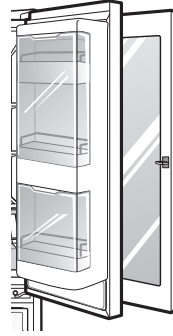

### InstaView Door-in-Door Compartment

To access the InstaView Door-in-Door compartment, lightly press the button on the right refrigerator door handle to open the door.



## InstaView Function

The InstaView function on the Door-in-Door lets you see if you're running low on frequently used items like beverages and snacks, without opening the refrigerator door.



- 1 Knock twice on the glass to turn the LED light inside the Door-in-Door on or off.
- 2 The LED light turns off automatically after ten seconds.
  - The InstaView Door-in-Door function is disabled when the right refrigerator door is open, for two seconds after closing the door, and when the ice dispenser is in use.
  - Knock near the center of the glass. Knocking near the edges of the glass may not activate the InstaView Door-in-Door function properly.
  - Knock hard enough that the knocking sound is audible.
  - The InstaView Door-in-Door function may activate if a loud noise occurs near the refrigerator.

## Door-in-Door Case

To open the Door-in-Door case, slightly push the marked area to pop it open. The Door-in-Door Case is removable for easy cleaning and adjustment.

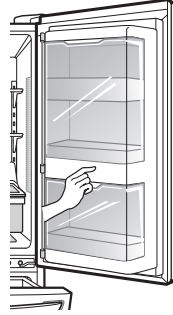

- 1 To remove the Door-in-Door case, lift up and pull out.

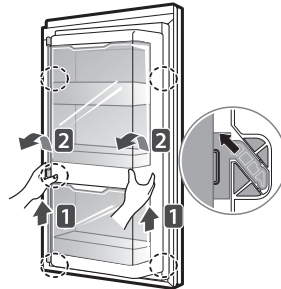

- 2 To replace the Door-in-Door case, line the tabs on the Door-in-Door case with the slots on the door and push down until it snaps into place.

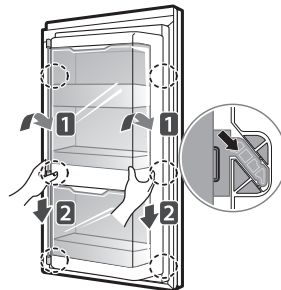

## CustomChill™ Drawer

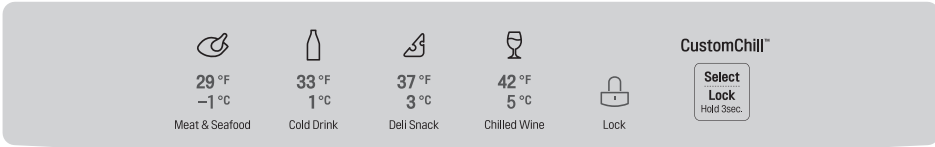

The CustomChill™ Drawer provides storage space with a variable temperature control that can be adjusted to keep the compartment either colder or warmer than the refrigerator.

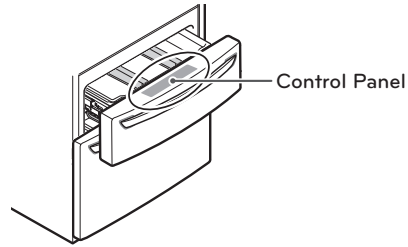

### Setting the Temperature



Press the Select/Lock button repeatedly to toggle through the four temperature settings. Store meat and seafood at 29°F/-1°C, cold drinks at 33°F/1°C, deli snacks at 37°F/3°C, or chilled wine at 42°F/5°C.

### Control Lock



The control panel can also be locked to prevent the temperature from accidentally being changed or tampered with by children. To lock the panel, press and hold the Select/Lock button for three seconds until the Lock icon lights up. To unlock the panel, press and hold the Select/Lock button until the Lock icon light turns off.

## Adjusting the Refrigerator Shelves

The shelves in your refrigerator are adjustable to meet your individual storage needs. Your model may have glass or wire shelves.

Adjusting the shelves to fit items of different heights will make finding the exact item you want easier. Doing so will also reduce the amount of time the refrigerator door is open which will save energy.

### Detaching the Shelf

Tilt up the front of the shelf and lift it straight up. Pull the shelf out.

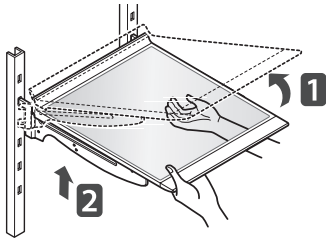

### Using the Folding Shelf

You can store taller items, such as a gallon container or bottles, by simply pushing the front half of the shelf underneath the back half of the shelf. Pull the front of the shelf toward you to return to a full shelf.

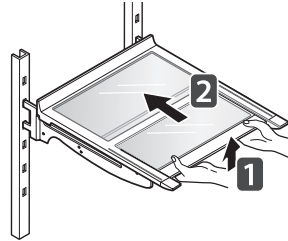

### CAUTION

- Do not clean glass shelves with warm water while they are cold. Shelves may break if exposed to sudden temperature changes or impact.
- Glass shelves are heavy. Use special care when removing them.

### Assembling the Shelf

Tilt the front of the shelf up and guide the shelf hooks into the slots at a desired height. Then, lower the front of the shelf so that the hooks drop into the slots.

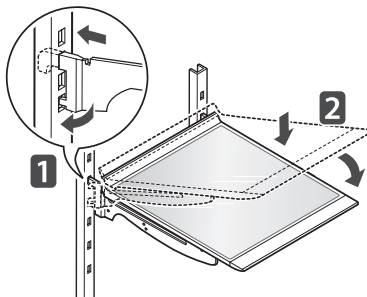

### CAUTION

Make sure that shelves are level from one side to the other. Failure to do so may result in the shelf falling or food spilling.

# MAINTENANCE

## Cleaning

- Both the refrigerator and freezer sections defrost automatically; however, clean both sections about once a month to prevent odors.
- Wipe up spills immediately.
- Always unplug the refrigerator before cleaning.

### General Cleaning Tips

- Unplug refrigerator or disconnect power.
- Remove all removable parts, such as shelves, crispers, etc.
- Use a clean sponge or soft cloth and a mild detergent in warm water. Do not use abrasive or harsh cleaners.
- Hand wash, rinse and dry all surfaces thoroughly.

### Exterior

Waxing external painted metal surfaces helps provide rust protection. Do not wax plastic parts. Wax painted metal surfaces at least twice a year using appliance wax (or auto paste wax). Apply wax with a clean, soft cloth.

For products with a stainless steel exterior, use a clean sponge or soft cloth and a mild detergent in warm water. Do not use abrasive or harsh cleaners. Dry thoroughly with a soft cloth.



#### CAUTION

- Do not use a rough cloth or sponge when cleaning the interior and exterior of the refrigerator.
- Do not place your hand on the bottom surface of the refrigerator when opening and closing.



#### WARNING

Use non-flammable cleaner. Failure to do so can result in fire, explosion, or death.

### Inside Walls

**(Allow the freezer to warm up so that the cloth will not stick.)**

To help remove odors, you can wash the inside of the refrigerator with a mixture of baking soda and warm water. Mix 2 tablespoons of baking soda to 1 quart of water (26 g soda to 1 liter water) Be sure the baking soda is completely dissolved so it does not scratch the surfaces of the refrigerator.

### Door Liners and Gaskets

Use a clean sponge or soft cloth and a mild detergent in warm water. Do not use cleaning waxes, concentrated detergents, bleaches, or cleaners containing petroleum on plastic refrigerator parts.

### Plastic Parts (covers and panels)

Use a clean sponge or soft cloth and a mild detergent in warm water. Do not use glass cleaners, abrasive cleansers, or flammable fluids. These can scratch or damage the material.

### Condenser Coils

Use a vacuum cleaner with an attachment to clean the condenser cover and vents. Do not remove the panel covering the condenser coil area.

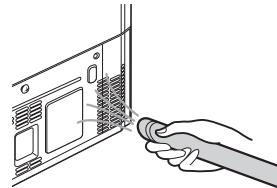



## Replacing the Fresh Air Filter

It is recommended that you replace the air filter:

- Approximately every six months.
- When the CHANGE FILTER light turns on.

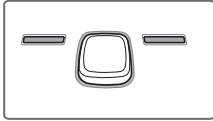

### 1 Remove the Old Filter

Turn the filter cover to the left to detach from the refrigerator wall. The filter is located on the inside of the filter cover. Remove the filter from the cover and replace it with a new filter.

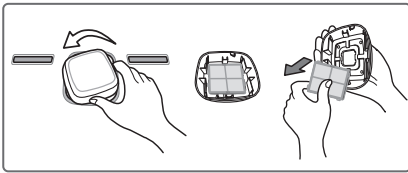

### 2 Install a New Air Filter.

Place the new filter inside of the cover with the side that says "Front" facing outward. Turn the filter cover to the right to attach to the refrigerator wall.

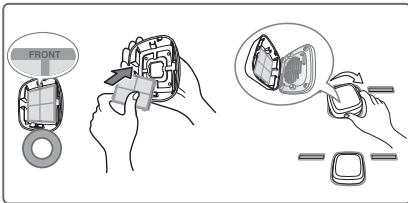

After changing the filter, push and hold the Air Filter button for three seconds to reset the filter sensor.

## Replacing the Water Filter

### ! NOTE

This refrigerator does not require a filter bypass plug when the filter is not in place.

It is recommended that you replace the water filter:

- Approximately every six months.
- When the water filter indicator turns on.
- When the water dispenser output decreases.
- When the ice cubes are smaller than normal.

### 1 Remove the old water filter.

Lift up and remove the lower door bin. Swing the right end of the water filter out of the compartment and then grasp and rotate the filter counterclockwise to remove it from the filter head.

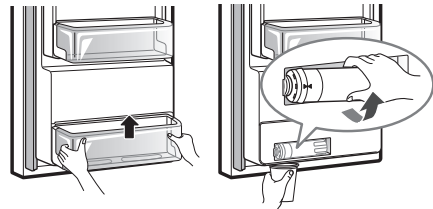

### ! NOTE

Replacing the water filter could cause a small amount of water to drain. Place a cup under the filter head to catch any water.

### 2 Replace with a new water filter.

Insert the new filter into the filter head and rotate it clockwise until the arrow on the new filter lines up with the arrow on the filter head. Swing the filter back into the compartment.

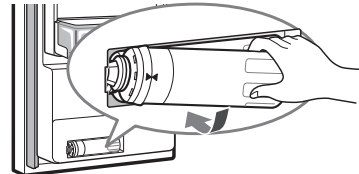

### 3 Assemble the door bin.

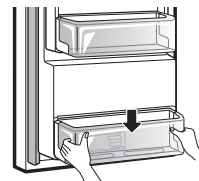

## Performance Data Sheet

Use Replacement Cartridge: MDJ64844601(LT1000P)

The concentration of the indicated substances in water entering the system was reduced to a concentration less than or equal to the permissible limit for water leaving the system as specified in NSF/ANSI Standard 42 and Standard 53 and Standard 401.



System tested and certified by NSF International against NSF/ANSI Standard 42, Standard 53 and Standard 401. For the reduction of substances listed below.

Contaminant Reduction	Average Influent Challenge	NSF specified Challenge Concentration	Avg % Reduction	Average Product Water Concentration	Max Permissible Product Water Concentration	NSF Reduction Requirement
Chlorine Taste and Odor	2.0 µg/L	2.0 µg/L ± 10%	>97.5%	0.050 µg/L	N/A	≥ 50.00%
Nominal Particulate Class I, ≥ 0.5 to < 1.0 µm	12,000,000 pts/mL	At least 10,000 particles/mL	99.80%	24,000 pts/ml	N/A	≥ 85.00%
Asbestos	180 MFL	10 <sup>7</sup> to 10 <sup>8</sup> MFL; fibers greater than 10 µg/L in length	>99.00%	< 1 MFL	N/A	≥ 99.00%
Atrazine	8.5 µg/L	9.0 µg/L ± 10%	>94.10%	0.500 µg/L	3.0 µg/L	NA
Benzene	15.0 µg/L	15.0 µg/L ± 10%	>96.60%	0.510 µg/L	5.0 µg/L	NA
Carbofuran	74.0 µg/L	80.0 µg/L ± 10%	98.30%	1.258 µg/L	40 µg/L	NA
Lindane	1.9 µg/L	2.0 µg/L ± 10%	>99.00%	0.019 µg/L	0.2 µg/L	NA
P-Dichlorobenzene	230.0 µg/L	225.0 µg/L ± 10%	>99.80%	0.460 µg/L	75.0 µg/L	NA
2,4-D	210.0 µg/L	210.0 µg/L ± 10%	>99.90%	0.210 µg/L	70.0 µg/L	NA
Lead @ pH 6.5	140.0 µg/L	150.0 µg/L ± 10%	99.60%	0.560 µg/L	10.0 µg/L	NA
Lead @ pH 8.5	150.0 µg/L	150.0 µg/L ± 10%	>90%	< 0.500 µg/L	10.0 µg/L	NA
Mercury @ pH 6.5	5.9 µg/L	6.0 µg/L ± 10%	91.00%	0.531 µg/L	2.0 µg/L	NA
Mercury @ pH 8.5	5.6 µg/L	6.0 µg/L ± 10%	92.50%	< 0.420 µg/L	2.0 µg/L	NA
Cyst*	100,000 cysts/L	Minimum 50,000 cysts/L	>99.99%	10	N/A	≥ 99.95%
Atenolol	240 ng/L	200 ± 40% ng/L	> 95.50%	10.80 ng/L	30 ng/L	NA
Carbamazepine	1600 ng/L	1400 ± 40% ng/L	98.40%	25.60 ng/L	200 ng/L	NA
DEET	1600 ng/L	1400 ± 40% ng/L	97.10%	46.40 ng/L	200 ng/L	NA
Trimethoprim	170 ng/L	140 ± 40% ng/L	>96.80%	5.44 ng/L	20 ng/L	NA
Linuron	160 ng/L	140 ± 40% ng/L	>96.60%	5.44 ng/L	20 ng/L	NA
Phenytoin	200 ng/L	200 ± 40% ng/L	>94.80%	10.40 ng/L	30 ng/L	NA
Ibuprofen	400 ng/L	400 ± 40% ng/L	>94.50%	22.00 ng/L	60 ng/L	NA
Naproxen	140 ng/L	140 ± 40% ng/L	>96.10%	5.46 ng/L	20 ng/L	NA
Estrone	120 ng/L	140 ± 40% ng/L	>96.10%	4.68 ng/L	20 ng/L	NA
Bisphenol A	2000 ng/L	2000 ± 40% ng/L	>98.90%	22.00 ng/L	300 ng/L	NA
Nonyl Phenol	1600 ng/L	1400 ± 40% ng/L	>97.10%	46.40 ng/L	200 ng/L	NA

\* Based on the use of *Cryptosporidium parvum* oocysts.

## Application Guidelines / Water Supply Parameters

Note that while testing was performed under standard laboratory conditions, actual performance may vary.

<b>Service Flow</b>	0.5 gpm (1.9 lpm)
<b>Water Supply</b>	Community or private well — Potable Water
<b>Water Pressure</b>	20 -120 psi (138 - 827 kPa)
<b>Water Temperature</b>	33-100°F (0.6 -37.8°C)
<b>Capacity</b>	200 gallons (757 liters)

NSF System Trade Name Code :  
MDJ64844601(LT1000P)

It is essential that the manufacturer’s recommended installation, maintenance and filter replacement requirements be carried out for the product to perform as advertised.

Replacement Cartridge:  
MDJ64844601(LT1000P)

For estimated costs of replacement elements please visit our website at [www.lg.com](http://www.lg.com)

Refer to the Warranty section of this manual for information on the limited warranty.

## SAFETY INFORMATION

Read, understand, and follow all safety Information contained in these instructions prior to installation and use of this product. Retain these instructions for future reference.

### WARNING

To reduce the risk associated with the ingestion of contaminants:

- Do not use with water that is microbiologically unsafe or of unknown quality without adequate disinfection before or after the system. Systems certified for cyst reduction may be used on disinfected water that may contain filterable cysts.

### CAUTION

Please note that water could fall while replacing filter which could result property damage.

To reduce the risk associated with property damage due to water leakage:

- Read and follow Use Instructions before installation and use of this system.
- Installation must comply with existing state or local plumbing codes.
- Protect filter from Freezing. Drain filter when room temperature drops below 33°F (0.6°C).
- Do not install if water pressure exceeds 120 psi (827 kPa). If your water pressure exceeds 80 psi, you must install a pressure limiting valve. Contact a plumbing professional if you are uncertain how to check your water pressure.
- Do not install where water hammer conditions may occur. If water hammer conditions exist you must install a water hammer arrester. Contact a plumbing professional if you are uncertain how to check for this condition.
- Do not install on hot water supply lines. Install on cold water lines only. The maximum operating water temperature of this filter system is 100°F (37.8°C).
- Where a backflow prevention device is installed on a water system, a device for controlling pressure due to thermal expansion must be installed.
- The disposable filter cartridge must be replaced every six months, at the rated capacity or if a noticeable reduction in flow rate occurs.

NSF is a trademark of NSF International. LG is a trademark of LG Corp.

## SMART DIAGNOSIS

Should you experience any problems with your refrigerator, it has the capability of transmitting data via your telephone to the LG service center. This allows you to speak directly to our trained specialists. The specialist records the data transmitted from your machine and uses it to analyze the issue, providing a fast and effective diagnosis.

If you experience problems with your refrigerator, call 1-800-243-0000. Only use the Smart Diagnosis™ feature when instructed to do so by the LG call center agent. The transmission sounds that you will hear are normal and sound similar to a fax machine.

Smart Diagnosis™ cannot be activated unless your refrigerator is connected to power. If your refrigerator is unable to turn on, then troubleshooting must be done without using Smart Diagnosis™.

### Using Smart Diagnosis™

First, call 1-800-243-0000. Only use the Smart Diagnosis™ feature when instructed to do so by the LG call center agent.

- 1 Lock the display. To lock the display, press and hold the Lock button for three seconds. (If the display has been locked for over five minutes, you must deactivate the lock and then reactivate it.)



- 2 Open the right refrigerator door.

- 3 Hold the mouthpiece of your phone in front of the speaker that is located on the right hinge of the refrigerator door, when instructed to do so by the call center.

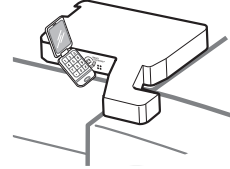

- 4 Press and hold the Freezer button for three seconds while continuing to hold your phone to the speaker.

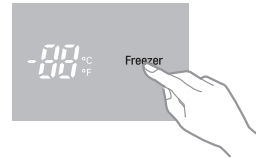

- 5 After you hear three beeps, release the Freezer button.
- 6 Keep the phone in place until the tone transmission has finished. This takes about 6 seconds, and the display will count down the time. Once the countdown is over and the tones have stopped, resume your conversation with the specialist, who will then be able to assist you in using the information transmitted for analysis.

#### NOTE

- For best results, do not move the phone while the tones are being transmitted.
- If the call center agent is not able to get an accurate recording of the data, you may be asked to try again.

#### NOTE

- Call quality differences by region may affect the function.
- Use a land line rather than a cell phone for better communication performance, resulting in better service.
- Bad call quality may result in poor data transmission from your phone to the machine, which could cause Smart Diagnosis™ to malfunction.

# TROUBLESHOOTING

Review the Troubleshooting section before calling for service; doing so will save you both time and money.

Problem	Possible Causes	Solutions
Refrigerator and Freezer section are not cooling.	The refrigerator control is set to OFF (some models).	Turn the control ON. Refer to the Setting the Controls section for proper temperature settings.
	Refrigerator is in the defrost cycle.	During the defrost cycle, the temperature of each compartment may rise slightly. Wait 30 minutes and confirm the proper temperature has been restored once the defrost cycle has completed.
	Refrigerator was recently installed.	It may take up to 24 hours for each compartment to reach the desired temperature.
	Refrigerator was recently relocated.	If the refrigerator was stored for a long period of time or moved on its side, it is necessary for the refrigerator to stand upright for 24 hours before connecting it to power.
Cooling System runs too much.	Refrigerator is replacing an older model.	Modern refrigerators require more operating time but use less energy due to more efficient technology.
	Refrigerator was recently plugged in or power restored.	The refrigerator will take up to 24 hours to cool completely.
	Door opened often or a large amount of food / hot food was added.	Adding food and opening the door warms the refrigerator, requiring the compressor to run longer in order to cool the refrigerator back down. In order to conserve energy, try to get everything you need out of the refrigerator at once, keep food organized so it is easy to find, and close the door as soon as the food is removed. (Refer to the Food Storage Guide.)
	Doors are not closed completely.	Firmly push the doors shut.
	Refrigerator is installed in a hot location.	The compressor will run longer under warm conditions. At normal room temperatures (70°F) expect your compressor to run about 40% to 80% of the time. Under warmer conditions, expect it to run even more often. The refrigerator should not be operated above 110°F.
	Condenser / back cover is clogged.	Use a vacuum cleaner with an attachment to clean the condenser cover and vents. Do not remove the panel covering the condenser coil area.

Problem	Possible Causes	Solutions
Refrigerator or Freezer section is too warm.	Refrigerator was recently installed.	It may take up to 24 hours for each compartment to reach the desired temperature.
	Air vents are blocked.	Rearrange items to allow air to flow throughout the compartment. Refer to the Airflow diagram in the Using Your Refrigerator section.
	Doors are opened often or for long periods of time.	When the doors are opened often or for long periods of time, warm, humid air enters the compartment. This raises the temperature and moisture level within the compartment. To lessen the effect, reduce the frequency and duration of door openings.
	Unit is installed in a hot location.	The refrigerator should not be operated in temperatures above 110°F.
	A large amount of food or hot food was added to either compartment.	Adding food warms the compartment requiring the cooling system to run. Allowing hot food to cool to room temperature before putting it in the refrigerator will reduce this effect.
	Doors not closed correctly.	See the Doors will not close correctly or pop open section in Troubleshooting.
	Temperature control is not set correctly.	If the temperature is too warm, adjust the control one increment at a time and wait for the temperature to stabilize. Refer to the Setting the Controls section for more information.
	Defrost cycle has recently completed.	During the defrost cycle, the temperature of each compartment may rise slightly and condensation may form on the back wall. Wait 30 minutes and confirm the proper temperature has been restored once the defrost cycle has completed.

Problem	Possible Causes	Solutions
Interior moisture buildup.	Doors are opened often or for long periods of time.	When the doors are opened often or for long periods of time, warm, humid air enters the compartment. This raises the temperature and moisture level within the compartment. To lessen the effect, reduce the frequency and duration of door openings.
	Doors not closed correctly.	See the Doors will not close correctly section in the Troubleshooting section.
	Weather is humid.	Humid weather allows additional moisture to enter the compartments when the doors are opened leading to condensation or frost. Maintaining a reasonable level of humidity in the home will help to control the amount of moisture that can enter the compartments.
	Defrost cycle recently completed.	During the defrost cycle, the temperature of each compartment may rise slightly and condensation may form on the back wall. Wait 30 minutes and confirm that the proper temperature has been restored once the defrost cycle has completed.
	Food is not packaged correctly.	Food stored uncovered or unwrapped, and damp containers can lead to moisture accumulation within each compartment. Wipe all containers dry and store food in sealed packaging to prevent condensation and frost.
Food is freezing in the refrigerator compartment.	Food with high water content was placed near an air vent.	Rearrange items with high water content away from air vents.
	Refrigerator temperature control is set incorrectly.	If the temperature is too cold, adjust the control one increment at a time and wait for the temperature to stabilize. Refer to the Setting the Controls section for more information.
	Refrigerator is installed in a cold location.	When the refrigerator is operated in temperatures below 41°F (5°C), food can freeze in the refrigerator compartment. The refrigerator should not be operated in temperatures below 55°F (13°C).
Frost or ice crystals form on frozen food (outside of package).	Door is opened frequently or for long periods of time.	When the doors are opened often or for long periods of time, warm, humid air enters the compartment. This raises the temperature and moisture level within the compartment. Increased moisture will lead to frost and condensation. To lessen the effect, reduce the frequency and duration of door openings.
	Door is not closing properly.	Refer to the Doors will not close correctly or pop open section in the Troubleshooting section.
Refrigerator or Freezer section is too cold.	Incorrect temperature control settings.	If the temperature is too cold, adjust the control one increment at a time and wait for the temperature to stabilize. Refer to the Setting the Controls section for more information.

Problem	Possible Causes	Solutions
Frost or ice crystals on frozen food (inside of sealed package).	Condensation from food with a high water content has frozen inside of the food package.	This is normal for food items with a high water content.
	Food has been left in the freezer for a long period of time.	Do not store food items with high water content in the freezer for a long period of time.
Icemaker is not making enough ice.	Demand exceeds ice storage capacity.	The icemaker will produce approximately 70~182 cubes in a 24 hour period.
	House water supply is not connected, valve is not turned on fully, or valve is clogged.	Connect the refrigerator to a cold water supply with adequate pressure and turn the water shutoff valve fully open. If the problem persists, it may be necessary to contact a plumber.
	Water filter has been exhausted.	It is recommended that you replace the water filter: <ul style="list-style-type: none"> <li>• Approximately every six months.</li> <li>• When the water filter indicator turns on.</li> <li>• When the water dispenser output decreases.</li> <li>• When the ice cubes are smaller than normal.</li> </ul>
	Low house water supply pressure.	The water pressure must be 20~120 psi or 138~827 kPa or 1.4~8.4 kgf/cm <sup>2</sup> on models without a water filter and 40~120 psi or 276~827 kPa or 2.8~8.4 kgf/cm <sup>2</sup> on models with a water filter.  If the problem persists, it may be necessary to contact a plumber.
	Reverse Osmosis filtration system is used.	Reverse osmosis filtration systems can reduce the water pressure below the minimum amount and result in icemaker issues. (Refer to Water Pressure section.)
	Tubing connecting refrigerator to house supply valve is kinked.	The tubing can kink when the refrigerator is moved during installation or cleaning resulting in reduced water flow. Straighten or repair the water supply line and arrange it to prevent future kinks.



Problem	Possible Causes	Solutions
Icemaker is not making enough ice (continued).	Doors are opened often or for long periods of time.	If the doors of the unit are opened often, ambient air will warm the refrigerator which will prevent the unit from maintaining the set temperature. Lowering the refrigerator temperature can help, as well as not opening the doors as frequently.
	Doors are not closed completely.	If the doors are not properly closed, ice production will be affected. See the Doors will not close completely or pop open section in Parts & Features Troubleshooting for more information.
	The temperature setting for the freezer is too warm.	The recommended temperature for the freezer compartment for normal ice production is 0°F. If the freezer temperature is warmer, ice production will be affected.
Dispensing water slowly.	Water filter has been exhausted.	It is recommended that you replace the water filter: <ul style="list-style-type: none"> <li>• Approximately every six months.</li> <li>• When the water filter indicator turns on.</li> <li>• When the water dispenser output decreases.</li> <li>• When the ice cubes are smaller than normal.</li> </ul>
	Reverse osmosis filtration system is used.	Reverse osmosis filtration systems can reduce the water pressure below the minimum amount and result in icemaker issues.  If the problem persists, it may be necessary to contact a plumber.
	Low house water supply pressure.	The water pressure must be 20~120 psi or 138~827 kPa or 1.4~8.4 kgf/cm <sup>2</sup> on models without a water filter and 40~120 psi or 276~827 kPa or 2.8~8.4 kgf/cm <sup>2</sup> on models with a water filter.  If the problem persists, it may be necessary to contact a plumber.

Problem	Possible Causes	Solutions
Not dispensing ice.	Doors are not closed completely.	Ice will not dispense if any of the refrigerator doors are left open.
	Infrequent use of the dispenser.	Infrequent use of the ice dispenser will cause the cubes to stick together over time, which will prevent them from properly dispensing. Check the ice bin for ice cubes clumping/sticking together. If they are, break up the ice cubes to allow for proper operation.
	The delivery chute is clogged with frost or ice fragments.	Eliminate the frost or ice fragments by removing the ice bin and clearing the chute with a plastic utensil. Dispensing cubed ice can also help prevent frost or ice fragment buildup.
	The dispenser display is locked.	Press and hold the Lock button for three seconds to unlock the control panel and dispenser.
	Ice bin is empty.	It may take up to 24 hours for each compartment to reach the desired temperature and for the icemaker to begin making ice. Make sure that the shutoff (arm/sensor) is not obstructed.  Once the ice supply in the bin has been completely exhausted, it may take up to 90 minutes before additional ice is available, and approximately 24 hours to completely refill the bin.
Icemaker is not making ice.	Refrigerator was recently installed or icemaker recently connected.	It may take up to 24 hours for each compartment to reach the desired temperature and for the icemaker to begin making ice.
	Icemaker not turned on.	Locate the icemaker ON/OFF switch and confirm that it is in the ON (I) position.
	The ice detecting sensor is obstructed.	Foreign substances or frost on the ice-detecting sensor can interrupt ice production. Make sure that the sensor area is clean at all times for proper operation.
	The refrigerator is not connected to a water supply or the supply shutoff valve is not turned on.	Connect refrigerator to the water supply and turn the water shutoff valve fully open.
	Icemaker shutoff (arm or sensor) obstructed.	If your icemaker is equipped with an ice shutoff arm, make sure that the arm moves freely. If your icemaker is equipped with the electronic ice shutoff sensor, make sure that there is a clear path between the two sensors.
	Reverse osmosis water filtration system is connected to your cold water supply.	Reverse osmosis filtration systems can reduce the water pressure below the minimum amount and result in icemaker issues. (Refer to the Water Pressure section.)

Problem	Possible Causes	Solutions
Not dispensing water.	New installation or water line recently connected.	Dispense 2.5 gallons of water (flush for approximately 5 minutes) to remove trapped air and contaminants from the system. Do not dispense the entire 2.5 gallon amount continuously. Depress and release the dispenser pad for cycles of 30 seconds ON and 60 seconds OFF.
	The dispenser panel is locked.	Press and hold the Lock button for three seconds to unlock the control panel and dispenser.
	The dispenser is not set for water dispensing.	The dispenser can be set for ice or water. Make certain that the control panel is set for the proper operation. Press the Water button on the control panel to dispense water.
	Refrigerator or freezer doors are not closed properly.	Water will not dispense if any of the refrigerator doors are left open.
	Water filter has been recently removed or replaced.	After the water filter is replaced, dispense 2.5 gallons of water (flush for approximately 5 minutes) to remove trapped air and contaminants from the system. Do not dispense the entire 2.5 gallon amount continuously. Depress and release the dispenser pad for cycles of 30 seconds ON and 60 seconds OFF.
	Tubing connecting refrigerator to house supply valve is kinked.	The tubing can kink when the refrigerator is moved during installation or cleaning resulting in reduced water flow. Straighten or repair the water supply line and arrange it to prevent future kinks.
	The house water supply is not connected, the valve is not turned on fully, or the valve is clogged.	Connect refrigerator to the water supply and turn the water shutoff valve fully open.  If the problem persists, it may be necessary to contact a plumber.

Problem	Possible Causes	Solutions
Ice has bad taste or odor.	Water supply contains minerals such as sulfur.	A water filter may need to be installed to eliminate taste and odor problems.  NOTE: In some cases, a filter may not help. It may not be possible to remove all minerals / odor / taste in all water supplies.
	Icemaker was recently installed.	Discard the first few batches of ice to avoid discolored or bad tasting ice.
	Ice has been stored for too long.	Ice that has been stored for too long will shrink, become cloudy, and may develop a stale taste. Throw away old ice and make a new supply.
	The food has not been stored properly in either compartment.	Rewrap the food. Odors may migrate to the ice if food is not wrapped properly.
	The interior of the refrigerator needs to be cleaned.	See the Care and Cleaning section for more information.
	The ice storage bin needs to be cleaned.	Empty and wash the bin (discard old cubes). Make sure that the bin is completely dry before reinstalling it.
Dispensing warm water.	Refrigerator was recently installed.	Allow 24 hours after installation for the water storage tank to cool completely.
	The water dispenser has been used recently and the storage tank was exhausted.	Depending on your specific model, the water storage capacity will range from approximately 20 to 30 oz.
	Dispenser has not been used for several hours.	If the dispenser has not been used for several hours, the first glass dispensed may be warm. Discard the first 10 oz.
	Refrigerator is connected to the hot water supply.	Make sure that the refrigerator is connected to a cold water pipe.   <b>WARNING:</b> Connecting the refrigerator to a hot water line may damage the icemaker.
Water has bad taste or odor.	Water supply contains minerals such as sulfur.	A water filter may need to be installed to eliminate taste and odor problems.
	Water filter has been exhausted.	It is recommended that you replace the water filter: <ul style="list-style-type: none"> <li>• Approximately every 6 months.</li> <li>• When the water filter indicator turns on.</li> <li>• When the water dispenser output decreases.</li> <li>• When the ice cubes are smaller than normal.</li> </ul>
	Refrigerator was recently installed.	Dispense 2.5 gallons of water (flush for approximately 5 minutes) to remove trapped air and contaminants from the system. Do not dispense the entire 2.5 gallon amount continuously. Depress and release the dispenser pad for cycles of 30 seconds ON and 60 seconds OFF.

Problem	Possible Causes	Solutions
Icemaker is making too much ice.	Icemaker shutoff (arm/sensor) is obstructed.	Empty the ice bin. If your icemaker is equipped with an ice shutoff arm, make sure that the arm moves freely. If your icemaker is equipped with the electronic ice shutoff sensor, make sure that there is a clear path between the two sensors. Reinstall the ice bin and wait 24 hours to confirm proper operation.
Clicking	The defrost control will click when the automatic defrost cycle begins and ends. The thermostat control (or refrigerator control on some models) will also click when cycling on and off.	Normal Operation
Rattling	Rattling noises may come from the flow of refrigerant, the water line on the back of the unit, or items stored on top of or around the refrigerator.	Normal Operation
	Refrigerator is not resting solidly on the floor.	Floor is weak or uneven or leveling legs need to be adjusted. See the Door Alignment section.
	Refrigerator with linear compressor was jarred while running.	Normal Operation
Whooshing	Evaporator fan motor is circulating air through the refrigerator and freezer compartments.	Normal Operation
	Air is being forced over the condenser by the condenser fan.	Normal Operation
Gurgling	Refrigerant flowing through the cooling system.	Normal Operation
Popping	Contraction and expansion of the inside walls due to changes in temperature.	Normal Operation
Sizzling	Water dripping on the defrost heater during a defrost cycle.	Normal Operation
Vibrating	If the side or back of the refrigerator is touching a cabinet or wall, some of the normal vibrations may make an audible sound.	To eliminate the noise, make sure that the sides and back cannot vibrate against any wall or cabinet.
Dripping	Water running into the drain pan during the defrost cycle.	Normal Operation

Problem	Possible Causes	Solutions
Pulsating or High-Pitched Sound	Your refrigerator is designed to run more efficiently to keep your food items at the desired temperature. The high efficiency compressor may cause your new refrigerator to run longer than your old one, but it is still more energy efficient than previous models. While the refrigerator is running, it is normal to hear a pulsating or high-pitched sound.	Normal Operation
Doors will not close correctly or pop open.	Food packages are blocking the door open.	Rearrange food containers to clear the door and door shelves.
	Ice bin, crisper cover, pans, shelves, door bins, or baskets are out of position.	Push bins all the way in and put crisper cover, pans, shelves and baskets into their correct positions. See the Using Your Refrigerator section for more information.
	The doors were removed during product installation and not properly replaced.	Remove and replace the doors according to the Removing and Replacing Refrigerator Handles and Doors section.
	Refrigerator is not leveled properly.	See Door Alignment in the Refrigerator Installation section to level refrigerator.
Doors are difficult to open.	The gaskets are dirty or sticky.	Clean the gaskets and the surfaces that they touch. Rub a thin coat of appliance polish or kitchen wax on the gaskets after cleaning.
	Door was recently closed.	When you open the door, warmer air enters the refrigerator. As the warm air cools, it can create a vacuum. If the door is hard to open, wait one minute to allow the air pressure to equalize, then see if it opens more easily.
Refrigerator wobbles or seems unstable.	Leveling legs are not adjusted properly.	Refer to the Leveling and Door Alignment section.
	Floor is not level.	It may be necessary to add shims under the leveling legs or rollers to complete installation.
Lights do not work.	LED interior lighting failure.	The refrigerator compartment lamp is LED interior lighting, and service should be performed by a qualified technician.
Refrigerator has an unusual odor.	The Air Filter may need to be set to the MAX setting or replaced.	Set the Air Filter to the MAX setting. If the odor does not go away within 24 hours, the filter may need to be replaced. See the Replacing the Air Filter section for replacement instructions.
The interior of the refrigerator is covered with dust or soot.	The refrigerator is located near a fire source, such as a fireplace, chimney or candle.	Make sure that the refrigerator is not located near a fire source, such as a fireplace, chimney or candle.

## WARRANTY (USA)

Should your LG Refrigerator ("Product") fail due to a defect in materials or workmanship under normal home use, during the warranty period set forth below, LG will at its option repair or replace the product. This limited warranty is valid only to the original retail purchaser of the product and applies only when purchased and used within the United States including U.S. Territories. Proof of original retail purchase is required to obtain warranty service under this limited warranty.

WARRANTY PERIOD			
Refrigerator	Sealed System (Condenser, Dryer, Connecting Tube, Refrigerant and Evaporator)		Linear Compressor
One (1) year from the date of original retail purchase	One (1) year from the date of original retail purchase	Seven (7) years from the date of original retail purchase	Ten (10) years from the date of original retail purchase
Parts and Labor (internal/functional parts only)	Parts and Labor	Parts only (Consumer will be charged for labor)	Part only (Consumer will be charged for labor)

Noises associated with normal operation and failure to follow instructions found in the use and care and installation guides or operating the unit in an unsuitable environment will not be covered under this warranty.

- ▶ Replacement products and parts are warranted for the remaining portion of the original warranty period or ninety (90) days, whichever is greater.
- ▶ Replacement products and parts may be new or remanufactured.

**THIS WARRANTY IS IN LIEU OF ANY OTHER WARRANTY, EXPRESS OR IMPLIED, INCLUDING WITHOUT LIMITATION, ANY WARRANTY OF MERCHANTABILITY OR FITNESS FOR A PARTICULAR PURPOSE. TO THE EXTENT ANY IMPLIED WARRANTY IS REQUIRED BY LAW, IT IS LIMITED IN DURATION TO THE EXPRESS WARRANTY PERIOD ABOVE. NEITHER THE MANUFACTURER NOR ITS U.S. DISTRIBUTOR SHALL BE LIABLE FOR ANY INCIDENTAL, CONSEQUENTIAL, INDIRECT, SPECIAL, OR PUNITIVE DAMAGES OF ANY NATURE, INCLUDING WITHOUT LIMITATION, LOST REVENUES OR PROFITS, OR ANY OTHER DAMAGE WHETHER BASED IN CONTRACT, TORT, OR OTHERWISE.** Some states do not allow the exclusion or limitation of incidental or consequential damages or limitations on how long an implied warranty lasts, so the above exclusion or limitation may not apply to you. This warranty gives you specific legal rights and you may also have other rights that vary from state to state.

**THIS LIMITED WARRANTY DOES NOT COVER:**

1. Service trips to deliver, pick up, install, or repair the product; instruct the customer on operation of the product; repair or replace fuses or correct wiring or plumbing, or correction of unauthorized repairs/installation.
2. Failure of product to perform during power failures and interruptions or inadequate electrical service.
3. Damage caused by leaky or broken water pipes, frozen water pipes, restricted drain lines, inadequate or interrupted water supply or inadequate supply of air.
4. Damage resulting from operating the product in a corrosive atmosphere or contrary to the instructions outlined in the product owner's manual.
5. Damage to the product caused by accidents, pests and vermin, lightning, wind, fire, floods, or acts of God.
6. Damage resulting from misuse, abuse, improper installation, repair, or maintenance. Improper repair includes use of parts not approved or specified by LG.
7. Damage or failure caused by unauthorized modification or alteration, or if it is used for other than the intended purpose, or any water leakage where the unit was not properly installed.
8. Damage or failure caused by incorrect electrical current, voltage, or plumbing codes, commercial or industrial use, or use of accessories, components, or consumable cleaning products that are not approved by LG.
9. Damage caused by transportation and handling, including scratches, dents, chips, and/or other damage to the finish of your product, unless such damage results from defects in materials or workmanship and is reported within one (1) week of delivery (Call: 1-800-243-0000).
10. Damage or missing items to any display, open box, discounted, or refurbished product.
11. Products with original serial numbers that have been removed, altered, or can not be readily determined. Model and Serial numbers, along with original retail sales receipt, are required for warranty validation.
12. Increases in utility costs and additional utility expenses.
13. Replacement of light bulbs, filters, or any consumable parts.
14. Repairs when your product is used in other than normal and usual household use (e.g. commercial use, offices, and recreational facilities) or contrary to the instructions outlined in the product owner's manual.
15. Costs associated with removal of your product from your home for repairs.
16. The removal and reinstallation of the product if it is installed in an inaccessible location or is not installed in accordance with published installation instructions, including LG's owner's and installation manuals.
17. Shelves, door bins, drawers, handles, accessories, and other parts besides those that were originally included with this particular model.
18. Service trips to your home to teach you how to use the product.
19. Replacement of the water filter cartridge due to water pressure that is outside the specified operating range or due to excessive sediment in the water supply.

**The cost of repair or replacement under these excluded circumstances shall be borne by the consumer.**

**For complete warranty details and customer assistance, please call or visit our website:**

Call 1-800-243-0000 (24 hours a day, 365 days a year) and select the appropriate option from the menu, or visit our website at <http://www.lg.com> Or by mail: LG Customer Information Center: P. O. Box 240007, 201 James Record Road Huntsville, Alabama 35813 ATTN: CIC

Write your warranty information below: \_\_\_\_\_  
 Product Registration Information: \_\_\_\_\_  
 Model: \_\_\_\_\_  
 Serial Number: \_\_\_\_\_  
 Date of Purchase: \_\_\_\_\_



## WARRANTY (Canada)

**WARRANTY:** Should your LG Refrigerator ("Product") fail due to a defect in material or workmanship under normal home use during the warranty period set forth below, LG Canada will at its option repair or replace the Product upon receipt of proof of original retail purchase. This warranty is valid only to the original retail purchaser of the product and applies only to a Product distributed in Canada by LG Canada or an authorized Canadian distributor thereof. The warranty only applies to Products located and used within Canada.

<b>WARRANTY PERIOD:</b> (Note: If the original date of purchase can not be verified, the warranty will begin sixty (60) days from the date of manufacture)			
<b>Refrigerator/ Freezer</b>	<b>Sealed System (Condenser, Dryer, Connecting Tube, Refrigerant and Evaporator)</b>		<b>Linear Compressor</b>
<b>One (1) year from the date of original retail purchase</b>	<b>One (1) year from the date of original retail purchase</b>	<b>Seven (7) years from the date of original retail purchase</b>	<b>Ten (10) years from the date of original retail purchase</b>
Parts and Labor (internal/functional parts only)	Parts and Labor	Parts only (Consumer will be charged for labor)	Part only (Consumer will be charged for labor)

Noises associated with normal operation and failure to follow instructions found in the use and care and installation guides or operating the unit in an unsuitable environment will not be covered under this warranty.

- ▶ Replacement products and parts are warranted for the remaining portion of the original warranty period or ninety (90) days, whichever is greater.
- ▶ Replacement products and parts may be new or remanufactured.
- ▶ LG Authorized Service Center warranties their repair work for thirty (30) days.

**LG CANADA'S SOLE LIABILITY IS LIMITED TO THE WARRANTY SET OUT ABOVE. EXCEPT AS EXPRESSLY PROVIDED ABOVE, LG CANADA MAKES NO AND HEREBY DISCLAIMS ALL OTHER WARRANTIES AND CONDITIONS RESPECTING THE PRODUCT, WHETHER EXPRESS OR IMPLIED, INCLUDING, BUT NOT LIMITED TO, ANY IMPLIED WARRANTY OR CONDITION OF MERCHANTABILITY OR FITNESS FOR A PARTICULAR PURPOSE, AND NO REPRESENTATIONS SHALL BE BINDING ON LG CANADA. LG CANADA DOES NOT AUTHORIZE ANY PERSON TO CREATE OR ASSUME FOR IT ANY OTHER WARRANTY OBLIGATION OR LIABILITY IN CONNECTION WITH THE PRODUCT. TO THE EXTENT THAT ANY WARRANTY OR CONDITION IS IMPLIED BY LAW, IT IS LIMITED TO THE EXPRESS WARRANTY PERIOD ABOVE. LG CANADA, THE MANUFACTURER OR DISTRIBUTOR SHALL NOT BE LIABLE FOR ANY INCIDENTAL, CONSEQUENTIAL, SPECIAL, DIRECT OR INDIRECT DAMAGES, LOSS OF GOODWILL, LOST PROFITS, PUNITIVE OR EXEMPLARY DAMAGES OR ANY OTHER DAMAGE, WHETHER ARISING DIRECTLY OR INDIRECTLY FROM ANY CONTRACTUAL BREACH, FUNDAMENTAL OR OTHERWISE, OR FROM ANY ACTS OR OMISSIONS, TORT, OR OTHERWISE.** This warranty gives you specific legal rights. You may have other rights which may vary from province to province depending on applicable provincial laws. Any term of this warranty that negates or varies any implied condition or warranty under provincial law is severable where it conflicts with provincial law without affecting the remainder of this warranty's terms.

**THIS LIMITED WARRANTY DOES NOT COVER:**

1. Service trips to deliver, pick up, or install the product; instructing a customer on operation of the product; repair or replacement of fuses or correction of wiring or plumbing, or correction of unauthorized repairs/installation.
2. Failure of the product to perform during power failures and interruptions or inadequate electrical service.
3. Damage caused by leaky or broken water pipes, frozen water pipes, restricted drain lines, inadequate or interrupted water supply or inadequate supply of air.
4. Damage resulting from operating the Product in a corrosive atmosphere or contrary to the instructions outlined in the Product owner's manual.
5. Damage to the Product caused by accidents, pests and vermin, lightning, wind, fire, floods, or acts of God.
6. Damage resulting from the misuse, abuse, improper installation, repair, or maintenance of the Product. Improper repair includes use of parts not approved or specified by LG Canada.
7. Damage or product failure caused by unauthorized modification or alteration, or use for other than its intended purpose, or resulting from any water leakage due to improper installation.
8. Damage or Product failure caused by incorrect electrical current, voltage, or plumbing codes, commercial or industrial use, or use of accessories, components, or cleaning products that are not approved by LG Canada.
9. Damage caused by transportation and handling, including scratches, dents, chips, and/or other damage to the finish of your product, unless such damage results from defects in materials or workmanship and is reported within one (1) week of delivery.
10. Damage or missing items to any display, open box, discounted, or refurbished Product.
11. Products with original serial numbers that have been removed, altered, or cannot be readily determined. Model and Serial numbers, along with original retail sales receipt, are required for warranty validation.
12. Increases in utility costs and additional utility expenses.
13. Replacement of light bulbs, filters, or any consumable parts.
14. Repairs when your Product is used in other than normal and usual household use (including, without limitation, commercial use, in offices or recreational facilities) or contrary to the instructions outlined in the Product owner's manual.
15. Costs associated with removal of the Product from your home for repairs.
16. The removal and reinstallation of the Product if it is installed in an inaccessible location or is not installed in accordance with published installation instructions, including the Product owner's and installation manuals.
17. Shelves, door bins, drawers, handles, and accessories to the Product. Also excluded are parts besides those that were originally included with the Product.
18. Service trips to your home to teach you how to use the product.
19. Replacement of the water filter cartridge due to water pressure that is outside the specified operating range or due to excessive sediment in the water supply.

**All costs associated with the above excluded circumstances shall be borne by the consumer.**

**For complete warranty details and customer assistance, please call or visit our website:**

Call 1-888-542-2623 (24 hours a day, 365 days a year) and select the appropriate option from the menu, or visit our website at <http://www.lg.com>

Write your warranty information below: \_\_\_\_\_  
 Product Registration Information: \_\_\_\_\_  
 Model: \_\_\_\_\_  
 Serial Number: \_\_\_\_\_  
 Date of Purchase: \_\_\_\_\_



**LG Customer Information Center**

For inquiries or comments,  
visit [www.lg.com](http://www.lg.com) or call;

**1-800-243-0000** USA, Consumer User

**1-888-865-3026** USA, Commercial User

**1-888-542-2623** CANADA

**Register your product Online!**

[www.lg.com](http://www.lg.com)